

GLOBAL

Our experience. Your success



SHOE CATALOGUE 2019

STROBEL



GLOBAL SHOE CONSULTING

Over the last decade, Global has specialized itself in manufacturing sewing machines for almost any kind of shoe.

Apart from manufacturing Sewing Technologies, we see the growing demand for consulting assistance and training requirement to use the shoe technologies to its best.

To serve our customers and clients, we strongly believe that an end to end solution as part of customer service is required. Since 2 years under the roof of Global, we offer an independent service of shoe consultancy.

Global Shoe Consulting offers well founded, practical and easy to integrate advises / solutions for the needs in shoe production. Mainly for the closing areas together with our high qualified and experience partners we can offer the services for all areas from development, production and process planning.

Global Shoe Consulting assists especially on the following topics:

- Closing room optimization – analysis and optimizations
- Reorganisations of the production (from store – warehouse)
- Factory planning
- Coaching
- Operator training
- Methodical trainings
- Calculations – efficiency improvement
- Style wise calculations – process optimization

How to get started?

To get a better view on the current situation and circumstances, we prepared a questionnaire survey, which has to be filled in.

Based on this we get a first idea what might be or can be done and how long it will take to analyse the current circumstances. Depending on the size and the requirement fixed by the customer a first visit of the production facilities is required.

Here we will capture data and later a systematic assessment, evaluation of current state we are able to provide a consultancy.

A concept of different possibilities with budgeting, selection of optimal solutions. Implementation and training of staff and operators etc.



G.S.C

Global Shoe Consulting

Hendrik Figeeweg 4
2031 BJ Haarlem | The Netherlands
info@globalsew.com
globalsew.com
+31 (0)23 5319584



Our experience. Your success

OUR COMPANY



OUR MUSEUM



Welcome at GLOBAL

Member of the imca group

As one of the largest distributors in the field of industrial sewing machines, Global International has a reputation to live up to. We believe that the quality of business is just as important as the quality of life and that's why we always give a customer the best possible service for our products.

In our 12000 m² headquarters in Holland we keep a large stock of machines and parts as well and an unique museum, which shows the history of the sewing machine. You are always welcome to visit us in our Holland headquarters.



GLOBAL

SELECTION CONTENTS

THE COLOUR STRUCTURE OF THE GLOBAL SELECTION LEAFLETS REPRESENTS THE CHARACTERISTICS OF THE MACHINES.

ZIG-ZAG MACHINES

PATTERN STITCH MACHINES

SHOE PRODUCTION MACHINES

SPECIAL SHOE PRODUCTION MACHINES

SKIVING/CUTTING MACHINES

WALKING FOOT MACHINES



Global International offers you a wide range of industrial sewing machines named

'The Global Selection'

This is a selected group of machines produced in our own factories and by some of the industry's most reputable machine manufacturers.

The shortest way to GLOBAL

Global is located in Haarlem, Holland, only 15 minutes from Amsterdam and Schiphol Airport. Global is easy to reach by motorway from all major cities.





STROBEL 441-1

NEW SINGLE THREAD OVERSEAMING MACHINE FOR ATTACHING THE INSOLES (STROBEL CONSTRUCTION)

With this sturdy overseaming machine, insoles are sewn on to the uppers. In relation to the conventional lasting method, with the STROBEL method there will be less rejected shoes. With this machine leathers or textiles up to a thickness of 7 mm can be sewn. Thereby the gathering device helps to sew in fullness of the upper. Optional equipment (different feed and front cups) enables the machine to manufacture children shoes or sew very delicate material. Optional kits for string-lasting (with strings up to 2,5 mm diameter) or California-type shoes are available.

Nuevo máquina de coser plantillas. Con esta robusta máquina, se cose las plantillas al parte superior del zapato. En relación con el método convencional, el sistema Strobel se ahorra bastante material. Cose hasta 7 mm. de grosor de material. El plisador ayude coser la plantilla por completa al parte superior. Equipamiento opcional (como diferentes platos de arrastre o carretilla) habilita la máquina de producir calzado de niño o coser materiales muy delicados. Opcional conjuntos para jaretear (de cordón hasta 2,5mm. de diametro) o tipo californiano están disponibles.

Neue Einfaden- Überwendlichmaschine zum Einnähen von Brandsohlen. Mit dieser robusten Tellertransportmaschine werden Brandsohlen mit dem Schaft vernäht. Verglichen mit der konventionellen „Zwick“ Methode spart das „strobeln“ eine Menge Obermaterial. Sowohl Leder als auch Stoff bis zu 7 mm Stärke können mit dieser Maschine genäht werden Dabei erleichtert die sogenannte Einhaltevorrichtung das saubere einarbeiten von Mehrmaterial des Schaftes. Optional sind verschiedene Transportteller erhältlich mit denen Kinderschuhe, oder extrem empfindliche Materialien genäht werden können. Desweiteren sind auch Teilesätze für „String Lasting“ (mit Schnüren bis zu 2,5mm Dicke) und für California Schuhe erhältlich.

Nova máquina de transmissão de linha única para encaixar o insole. Com esta robusta máquina de "overseaming", as palmilhas são costuradas na parte superior. Em relação ao método de duração convencional, o método Strobel economiza bastante material. Com esta máquina podem ser costurados couros ou têxteis até uma espessura de 7 mm e é ideal para costurar a plenitude da parte superior do sapato. O equipamento opcional (alimentação diferente e copos dianteiros) permite que a máquina produza calçados infantis ou costure materiais muito delicados. Kits opcionais para corda (com cordas até 2,5 mm de diâmetro) ou calçados do tipo "Califórnia" estão disponíveis.

TECHNICAL SPECIFICATIONS

MACHINE SPEED
max 1800 spm

OILING SYSTEM
fully automatic

STITCH LENGTH
3 - 8 mm depends on sewing material

SEWING THICKNESS
max 7 mm

NEEDLE TYPE
134

OPTIONAL

- Pneumatic thread trimmer
- Equipment for stringlasting
- Pneumatic presserfoot lift

STROBEL 441-2 PROGRAMMING DIFFERENTIAL TRANSPORT

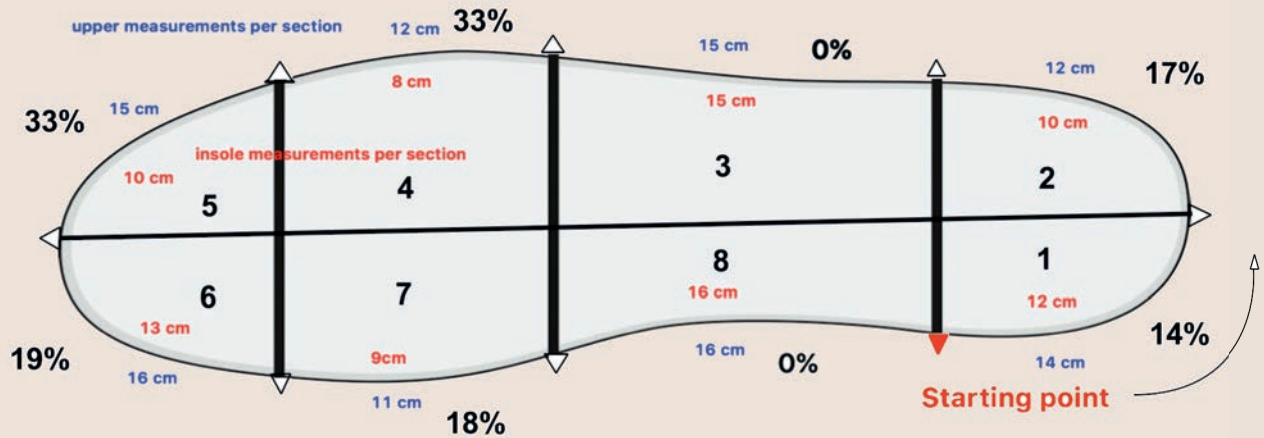

Differential Level	Differential percentage		
Level 0	0 - 2 %	Level 5	25 - 30 %
Level 1	3 - 8 %	Level 6	31 - 35 %
Level 2	9 - 13 %	Level 7	36 - 41 %
Level 3	14 - 19 %	Level 8	42 - 46 %
Level 4	20 - 24 %	Level 9	47 - 50 %



Pneumatic gathering device (option).



Pneumatic thread trimmer (option).



Material guide:
00186.0458 - height 4,5 mm
00186.0459 - height 3,5 mm

FEEDCUPS

Standard configuration:

182.0339

Heavy teeth 2,2mm pitch, edge height 3,0mm
Material guide 4,5mm

Suitable for example:

- Sport shoes
- Light weight safety shoes
- Hiking boots



182.0254

Heavy teeth 2,2mm pitch, edge height 1,5mm.
Material guide 3,5mm

Suitable for example:

- Fashionable mens shoes



182.0255

Fine teeth 1,5mm pitch pyramid edge height 1,5mm
Material guide 3,5mm.

Suitable for example:

- Fashionable ladies shoes



182.0341 (At extra cost).

Rubber coated feed cup, edge height 7,5mm
Material guide 3,5mm.

Suitable for example:

- Sensitive natural or PU leather
- Goretex or similar breathable waterproof fabrics.

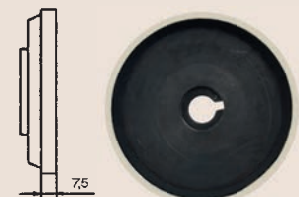

NOTE:

We advice to purchase a thread trimmer device in combination with a rubber coated feed cup!



STROBEL 441-2

NEW PROGRAMMABLE SINGLE THREAD OVERSEAMING MACHINE FOR ATTACHING THE INSOLES (STROBEL CONSTRUCTION)

With this sturdy overseaming machine, insoles are sewn on to the uppers. In relation to the conventional lasting method, with the STROBEL method there will be less rejected shoes. With this machine leathers or textiles up to a thickness of 7 mm can be sewn. This machine is equipped with a stepmotor for differential feed, to realize up to a maximum of 50% gathering. You can store 100 programs, 50 right/ 50 left shoes, with up to 10 sections of gathering in each program. The required percentage of gathering can be programmed in each section. Programs are saved in pairs. Program the right shoe, the left is automatically saved. The program mode allows you to work in pairs or individually left or right shoes. The optional pneumatic gathering device can be used to achieve optimal gathering results (depending on the material). It is also possible to manually control the stepmotor for gathering by using the foot pedal.

Nuevo máquina programable de coser plantillas. Con esta robusta máquina, se cose las plantillas al parte superior del zapato. Con el método de Strobel habrán menos pares de zapatos rechazados, que el método convencional del montaje. Cose hasta 7 mm. de grosor de material. La máquina esta equipada con un motor paso a paso para un arrastre diferencial, para lograr hasta un máximo de 50 % de plisado. Se puede grabar 100 diferentes programas, 50 pie derecho / 50 pie izquierdo, con hasta 10 distintos secciones de plisado en cada programa. La cantidad de plisado puede ser programado en cada sección. Los programas son guardados en pares. Cuando programas el zapato derecho, se guardará automáticamente el izquierdo. El programa permite trabajar en modo de pares o individualmente con zapato izquierdo o derecho. El plisador neumático opcional es util para obtener un resultado de plisado optimal (pendiente el material). También es posible de usar el control de plisado con motor diferencial manual a través el pedal de plisado.

Neue programmierbare, Einfaden- Überwendlichmaschine zum einnähen von Brandsohlen. Mit dieser robusten Tellertransportmaschine werden Brandsohlen mit dem Schaft vernäht. Verglichen mit der traditionellen Methode des Zwickens, produziert das Strobeln wesentlich weniger Ausschuss Sowohl Leder als auch Stoff bis zu 7 mm Stärke können mit dieser Maschine genäht werden Die Maschine ist mit einem Schrittmotor ausgerüstet der den äußeren Teller separat antreibt und so einen Differenzialtransport ermöglicht der es erlaubt bis zu 50% Mehrmaterial einfach und gleichmäßig einzuarbeiten. Es können 100 Programme (50 rechte und 50 linke Schuhe) gespeichert werden und jedes Programm kann bis zu 10 verschiedene Differenzialsektionen enthalten. Das jeweils notwendige Differential wird in jeder Sektion einprogrammiert. Die Programme werden in Paaren gespeichert, das heißt, wenn der rechte Schuh programmiert ist wird der linke Schuh automatisch, als Spiegelung, mitgespeichert. Der Programm Modus erlaubt es entweder in Paaren oder nur mit rechten oder nur mit linken Schuhen zu arbeiten. Die optional erhältliche, pneumatische Einhaltevorrichtung verstärkt den Differenzialtransport noch mehr was bei bestimmten Materialien notwendig werden könnte. Der Schrittmotor kann auch über ein Fußpedal direkt gesteuert werden um das Differential während des Nähens anzupassen.

Nova máquina de transmissão programável para encaixar o insole. Com esta robusta máquina de "overseaming", as palmilhas são costuradas na parte superior. Em relação ao método de duração convencional, com o método STROBEL, haverá menos calçados rejeitados. Com esta máquina podem ser costurados couros ou têxteis até uma espessura de 7 mm. Esta máquina está equipada com um motor de passo para alimentação diferencial. É possível armazenar 100 programas, 50 para os sapatos do lado direito e 50 para os sapatos do lado esquerdo. Os programas são salvos em pares. Ao programar o sapato direito, o esquerdo é salvo automaticamente. O modo de programa permite que você trabalhe em pares ou individualmente em sapatos esquerdos ou direitos. O dispositivo de pneumática opcional pode ser usado para obter ótimos resultados (dependendo do material). Também é possível controlar manualmente o motor de passo usando o pedal de apoio.

TECHNICAL SPECIFICATIONS

MACHINE SPEED
max 1800 spm

OILING SYSTEM
fully automatic

STITCH LENGTH
3 - 8 mm depends on sewing material

SEWING THICKNESS
max 7 mm

NEEDLE TYPE
134

OPTIONAL

- Pneumatic gathering device
- Pneumatic thread trimmer

STROBEL VTD410EV SINGLE THREAD OVERSEAMING MACHINE FOR INSOLING

Diameter Diámetro Durchmesser Diamètre	Pitch Distancia entre dientes Teilung Coupe	Edge height Altura dientes Randhöhe Hauteur du bord	Equipment Especial Ausstattung Equipement	Optional Opcional Optional En option
68,75 mm	2,2 mm	2,5 mm		
68,75 mm	1,5 mm	2,5 mm		•
68,75 mm	2,2 mm	1,5 mm		•
68,75 mm	1,5 mm	1,5 mm		•

Feed cup / Plato transportadora / Transportteller / Coupelle de transport

Diameter Diámetro Durchmesser Diamètre	Pitch Distancia entre dientes Teilung Coupe	Edge height Altura dientes Randhöhe Hauteur du bord	Equipment Especial Ausstattung Equipement	Optional Opcional Optional En option
27,5 mm	2,2 mm	2,4 mm		
27,5 mm	1,5 mm	2,4 mm		•
27,5 mm	2,2 mm	1,5 mm		•
27,5 mm	1,5 mm	1,5 mm		•

Front cup / Plato auxiliar / Anpreßteller / Coupelle avant

Stitches / min Puntadas / min Stichzahl / min Nombre de points / min	Stitch length Largo de puntada Stichlänge Longueur de point	Thickness of material Grosor del material Materialstärke Épaisseur du matériau	Adjustable needle height Regulación de la altura de la aguja Nadelhöhenverstellbarkeit Réglage de la hauteur de l'aiguille	Differential cup feed Platos del transporte con diferencial Differential Tellertransport Entrainement a coupelles différentiel	Fullness, differentiable Fruncido ajustable Mehrwerte differenzierbar Embu différentiel	Needle system Sistema de aguja Nadelsystem Système d'aiguille	2 Thread tensions 2 tensiones de hilo 2 Fadenspannungen 2 tensions du fil	Arm space Espacio libre Durchgangsraum Espace du bras
1600	3.0 - 8.0 mm	<11.0 mm	•	•	<48%	134	•	150 mm

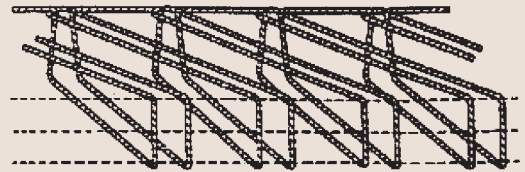

Stitch type 501





STROBEL VTD 410 EV

SINGLE THREAD OVERSEAMING MACHINE FOR INSOLING

The heavy cupfeed model VTD 410 EV can stitch even penetration resistant Kevlar soles with a material thickness of 11mm - Even at high speed! A separate "direct" drive ensures that the feed & front cup work to the millimeter. In addition, the differential feed allows this versatile machine to build in an extra 48% of fullness in to the seam as required. This eliminates the pre-gathering-operation. Special equipment for the production of such seams at the "California-Style" will be delivered on request.

El modelo VTD 410 EV de platos ajustables de transporte de materiales pesadas, puede incluso coser las suelas Kevlar resistente a la penetración con un grosorde material de 11 mm. y "a alta velocidad". El avance directo y separado asegura que el arrastre & el plato frontal trabajan al milimetro. Además el arrastre diferencial permite a esta máquina versátil para construir en 48 % additional de plenitud en la costura como se requiere, eliminando la fase de preparación. Equipamentos especiales para la producción de tipo de trabajo como "Estilo-California" serán atendidos a petición.

Die robuste VTD 410 EV vernäht selbst durch trittsichere Kevlarsohlen - und das mit hoher Geschwindigkeit bis zu einer Materialstärke von 11 mm. Der separaten Direktantriebe für Transport- und Anpressteller arbeitet auf den Milimeter genau. Dieser Differenzialtransport ermöglicht der VDT 410 EV eine exakte Weitenverteilung und das Einarbeiten von bis zu 48% Mehrweite. Dadurch kann das Vorraffen eingespart werden! Selbstverständlich erfüllen wir Ihnen Sonderwünsche, wie zum Beispiel die Ausstattung für die California- Verarbeitung.

La machine lourde avec entraînement cuvettes VTD 410 EV peut coudre des semelles en Kevlar avec une épaisseur de 11 mm, même à grande vitesse. Un entraînement séparé permet aux coupelles avant et arrière une précision du millimètre. Le différentiel permet un ajout de matière jusqu'à 48 %. Ceci permet d'éliminer l'opération de pré-fronçage. Des équipements spéciaux pour la production tel que le "Style Californien" sont livrable sur demande.

TECHNICAL SPECIFICATIONS

MACHINE SPEED
max 1600 spm

OILING SYSTEM
fully automatic

STITCH LENGTH
max 8 mm

NEEDLE TYPE
134

SEWING THICKNESS
max 11,0 mm



LP 8971 I-NP AUT



Global LP 8971 I Special Series HIGH SPEED POSTBED MACHINES

LP 8971 I-ST AUT

- High speed, single needle postbed machine, with top driven roller, wheel- and needle feed and standard hook. Machine is equipped with thread trimming device, which can be adjusted easily, for short thread ends trimming, automatic back tack and presser foot lift (all electric).

Because of the unique thread trimming device, remaining thread ends are only 6 mm long. The Ho Hsing direct drive mini servo motor, control box and control panel are integrated in the machine (All-in one).

- Máquina poste, 1 aguja de alta velocidad, motor mini servo incorporado con avance porruleta accionada, peine giratorio y garfio normal. Equipada con corta-hilos, remate y alza-prensataelasautomático y eléctrico. Porque el sistema único del dispositivo de corta-hilos, deja hilos sólo de 6 mm. de largo. Ho Hsing mini motor servo directo, caja de control y panel incorporada en la máquina (máquina todo incorporada).

- Hochgeschwindigkeits Einnadel Säulenmaschine mit angetriebenem Rollfuss, Schiebrad und Nadeltransport. Standardgreifer, Fadenabschneider, Automatische Verriegelung und Fusslüftung, jeweils elektrisch. Einzigartiger Kurz-Fadenabschneider mit 6 mm Fadenenden am Material. Die Ho Hsing Servomotor, Steuerung sowie das Bedienteil sind in die Maschine integriert (Alles in Einem).

- Machine pilier rapide une aiguille, avec servomoteur intégré à entraînement direct et boîte de contrôle (tout en 1). Entraînement par roue inférieure, aiguille et roulette supérieure. Crochet standard, dispositif coupe fil, point d'arrêt et relevage du pied automatique (l'ensemble en électrique). Grâce à son système coupe fil unique, l'extrémité de fil restante est seulement de 6 mm de long.

LP 8971 I-NP AUT

- High speed, single needle postbed machine, with top driven roller, wheel- and needle feed and standard hook. Machine equipped with thread trimming device, automatic back tack and presser foot lift (all electric). Because of the unique thread trimming device, remaining thread ends are only 6 mm long. This newly designed machine has a small right post to make it suitable for easy sewing on children's shoes. The Ho Hsing direct drive mini servo motor, control box and control panel are integrated in the machine (All-in one).

- Máquina poste, 1 aguja de alta velocidad, motor mini servo incorporado con avance porruleta accionada, peine giratorio y garfio normal. Equipada con corta-hilos, remate y alza-prensataelasautomático y eléctrico. Porque el sistema único del dispositivo de corta-hilos, deja hilos sólo de 6 mm. de largo. Ho Hsing mini motor servo directo, caja de control y panel incorporada en la máquina (máquina todo incorporada). Esta máquina de novedoso diseño cuenta con un poste pequeño ala derecha que la hace adecuada para el fácil cosido de zapatos para niños.

- Hochgeschwindigkeits Einnadel Säulenmaschine mit angetriebenem Rollfuss, Schiebrad und Nadeltransport. Standardgreifer, Fadenabschneider, Automatische Verriegelung und Fusslüftung, jeweils elektrisch. Einzigartiger Kurz-Fadenabschneider mit 6 mm Fadenenden am Material. Das neue Design und die schmale rechter Säule ermöglicht ein perfektes nähen auch im Bereich Kinderschuhe. Die Ho Hsing Servomotor, Steuerung sowie das Bedienteil sind in die Maschine integriert (Alles in Einem).

- Machine pilier rapide une aiguille, avec servomoteur intégré à entraînement direct et boîte de contrôle (tout en 1). Entraînement par roue inférieure, aiguille et roulette supérieure. Crochet standard, dispositif coupe fil, point d'arrêt et relevage du pied automatique (l'ensemble en électrique). Cette nouvelle machine est Dotée d'un pilier droite étroit particulièrement adapté pour une couture facile des chaussures d'enfants. Grâce à son système coupe fil unique, l'extrémité de fil restante est seulement de 6 mm de long.

TECHNICAL SPECIFICATIONS

MACHINE SPEED
max 2500 spm

OILING SYSTEM
fully automatic

FEED TYPE
needle and wheel feed top driven roller presser

STITCH LENGTH
LP 8971 I-ST AUT: max 7 mm
LP 8971 I-NP AUT: max 5 mm

PRESSER FOOT LIFT
by hand: 7 mm
by knee: 14 mm
automatic: 14 mm

NEEDLE TYPE
134

DIMENSION NARROW POST
170x43x49,2 mm



Pre-program system
(10 pattern's with each 15 steps)
in the memory of the touch screen



Global LP 8970 I Series

HIGH SPEED POSTBED MACHINES

LP 8971 I-AUT

- High speed, single needle postbed machine, with top driven roller, wheel- and needle feed and standard hook. Machine equipped with thread trimming device, automatic back tack and presser foot lift (all electric). The Ho Hsing direct drive mini servo motor, control box and control panel are integrated in the machine (All-in one).
- Máquina poste, 1 aguja de alta velocidad, motor mini servo incorporado con avance porruleta accionada, peine giratorio y garfio normal. Equipada con corta-hilos, remate y alza-prensateles automático y eléctrico. Ho Hsing mini motor servo directo, caja de control y panel incorporada en la máquina (máquina todo incorporada).
- Hochgeschwindigkeits Einnadel Säulenmaschine mit angetriebenem Rollfuss, Schiebrad und Nadeltransport. Standardgreifer, Fadenabschneider, Automatische Verriegelung und Fusslüftung, jeweils elektrisch. Die Ho Hsing Servomotor, Steuerung sowie das Bedienteil sind in die Maschine integriert (Alles in Einem).
- Machine pilier rapide une aiguille, avec servomoteur intégré à entraînement direct et boîte de contrôle (tout en 1). Entraînement par roue inférieure, aiguille et roulette supérieure. Crochet standard, dispositif coupe fil, point d'arrêt et relevage du pied automatique (l'ensemble en électrique).

LP 8971 I-LH-AUT(C)

- Same as LP 8971 I-AUT, but with large hook (Chinese).
- Las mismas características que le LP 8971 I-AUT, pero con garfio grande (Chino).
- Baugleich mit LP 8971 I-AUT, jedoch mit großem Greifer (Chinesisch).
- Identique à la LP 8971 I-AUT, équipée avec crochet grande (Chinois).

LP 8974 I-AUT

- Double needle postbed machine with wheel feed and top driven roller presser (no needle feed) and equipped with standard hooks, thread trimming device, automatic back tack and presser foot lift (all electric). The Ho Hsing direct drive mini servo motor, control box and control panel are integrated in the machine (All-in one).
- Máquina poste, 2 agujas de alta velocidad, avance porruleta accionada, peine giratorio y garfios normal. Equipada con corta-hilos, remate y alza-prensateles automático y eléctrico. Ho Hsing mini motor servo directo, caja de control y panel incorporada en la máquina (máquina todo incorporada).
- Hochgeschwindigkeits Zweinadel Säulenmaschine mit Angetriebener Rollfuss, Nadel- und Schiebradtransport, jeweils elektrisch. Standardgreifer, Fadenabschneider, automatische Verriegelung und Fusslüftung jeweils elektrisch. Die Ho Hsing Servomotor, Steuerung sowie das Bedienteil sind in die Maschine integriert (Alles in Einem).
- Machine pilier rapide deux aiguilles, avec servomoteur intégré à entraînement direct et boîte de contrôle (tout en 1). Entraînement par roue inférieure, aiguille et roulette supérieure. Crochet standard, dispositif coupe fil, point d'arrêt et relevage du pied automatique (l'ensemble en électrique).

TECHNICAL SPECIFICATIONS

MACHINE SPEED
max 2500 spm

OILING SYSTEM
Fully automatic

FEED TYPE
needle and wheel feed top driven roller presser (No needle feed on the LP 8974 I-AUT)

STITCH LENGTH
max 7 mm

PRESSER FOOT LIFT
by hand: 7 mm
by knee: 14 mm
automatic: 14 mm

NEEDLE TYPE
134 LR

DOUBLE NEEDLE TYPE
Standard needle gauge: 1,8mm
Optional gauges:
1,6mm, 2,0mm, 2,2mm, 2,4mm



LP 8971 E-NP AUT



Global LP 8971 E Special Series HIGH SPEED POSTBED MACHINES

LP 8971 E-ST AUT

- High speed, single needle postbed machine, with top driven roller, wheel- and needle feed and standard hook. Machine is equipped with thread trimming device, which can be adjusted easily, for short thread ends trimming, automatic back tack and presser foot lift (all electric).

Because of the unique thread trimming device, remaining thread ends are only 6 mm long. The HMC direct drive mini servo motor, control box and control panel are integrated in the machine (All-in one).

- Máquina poste, 1 aguja de alta velocidad, motor mini servo incorporado con avance porruleta accionada, peine giratorio y garfio normal. Equipada con corta-hilos, remate y alza-prensatelas automático y eléctrico. Porque el sistema único del dispositivo de corta-hilos, deja hilos sólo de 6 mm. de largo. HMC mini motor servo directo, caja de control y panel incorporada en la máquina (máquina todo incorporada).

- Hochgeschwindigkeits Einnadel Säulenmaschine mit angetriebenem Rollfuss, Schiebrad und Nadeltransport. Standardgreifer, Fadenabschneider, Automatische Verriegelung und Fusslüftung, jeweils elektrisch. Einzigartiger Kurz-Fadenabschneider mit 6 mm Fadenenden am Material. Die HMC Servomotor, Steuerung sowie das Bedienteil sind in die Maschine integriert (Alles in Einem).

- Machine pilier rapide une aiguille, avec servomoteur intégré à entraînement direct et boîte de contrôle (tout en 1). Entraînement par roue inférieure, aiguille et roulette supérieure. Crochet standard, dispositif coupe fil, point d'arrêt et relevage du pied automatique (l'ensemble en électrique). Grâce à son système coupe fil unique, l'extrémité de fil restante est seulement de 6 mm de long.

LP 8971 E-NP AUT

- High speed, single needle postbed machine, with top driven roller, wheel- and needle feed and standard hook. Machine equipped with thread trimming device, automatic back tack and presser foot lift (all electric). Because of the unique thread trimming device, remaining thread ends are only 6 mm long. This newly designed machine has a small right post to make it suitable for easy sewing on children's shoes. The HMC direct drive mini servo motor, control box and control panel are integrated in the machine (All-in one).

- Máquina poste, 1 aguja de alta velocidad, motor mini servo incorporado con avance porruleta accionada, peine giratorio y garfio normal. Equipada con corta-hilos, remate y alza-prensatelas automático y eléctrico. Porque el sistema único del dispositivo de corta-hilos, deja hilos sólo de 6 mm. de largo. HMC mini motor servo directo, caja de control y panel incorporada en la máquina (máquina todo incorporada). Esta máquina de novedoso diseño cuenta con un poste pequeño ala derecha que la hace adecuada para el fácil cosido de zapatos para niños.

- Hochgeschwindigkeits Einnadel Säulenmaschine mit angetriebenem Rollfuss, Schiebrad und Nadeltransport. Standardgreifer, Fadenabschneider, Automatische Verriegelung und Fusslüftung, jeweils elektrisch. Einzigartiger Kurz-Fadenabschneider mit 6 mm Fadenenden am Material. Das neue Design und die schmale rechter Säule ermöglicht ein perfektes nähen auch im Bereich Kinderschuhe. Die HMC Servomotor, Steuerung sowie das Bedienteil sind in die Maschine integriert (Alles in Einem).

- Machine pilier rapide une aiguille, avec servomoteur intégré à entraînement direct et boîte de contrôle (tout en 1). Entraînement par roue inférieure, aiguille et roulette supérieure. Crochet standard, dispositif coupe fil, point d'arrêt et relevage du pied automatique (l'ensemble en électrique). Cette nouvelle machine est Dotée d'un pilier droite étroit particulièrement adapté pour une couture facile des chaussures d'enfants. Grâce à son système coupe fil unique, l'extrémité de fil restante est seulement de 6 mm de long.

TECHNICAL SPECIFICATIONS

MACHINE SPEED
max 2500 spm

OILING SYSTEM
fully automatic

FEED TYPE
needle and wheel feed top driven roller presser

STITCH LENGTH
LP 8971 E-ST AUT: max 7 mm
LP 8971 E-NP AUT: max 5 mm

PRESSER FOOT LIFT
by hand: 7 mm
by knee: 14 mm
automatic: 14 mm

NEEDLE TYPE
134

DIMENSION NARROW POST
170x43x49,2 mm



LP 8974-E- AUT

Global LP 8970 E SERIES

HIGH SPEED POSTBED MACHINES

LP 8971 E-AUT

- High speed, single needle postbed machine, driven by HMC built-in mini servo motor, with top driven roller, wheel- and needle feed and standard hook. Machine equipped with thread trimming device, automatic back tack and presser foot lift (all electric).
- Máquina columna de alta velocidad de una aguja con mini motor HMC integrado, arrastre por ruleta accionada, agujas acompañantes y dientes circulares con retroceso y garfio normal. Equipada con corta-hilos, remate y alza-prensatelas (eléctrico).
- Máquina de columna 1 agulha, motor integrado na cabeça HMC, transporte, roletos acionados, agulha acompanhante, lançadeira pequena. Equipada com corte linha, remate automático, levantamento calcador (tudo electrico).
- Hochgeschwindigkeits-, Einnadel Säulenmaschine mit eingebautem HMC mini servo motor, oben angetriebenem Rollfuß, Schiebrad- und Nadeltransport und mit standard Greifer. Die Maschine ist mit Fadenabschneider, automatischer Verriegelung und Presserfußlüftung ausgestattet (elektrisch).
- Machine pilier rapide à une aiguille, avec mini moteur servo intégré HMC. Marche arrière entraînement par griffe, aiguille et pied à roulette et crochet standard. La machine est équipée d'un dispositif coupe fil, des arrêts automatiques et relevage du pied presseur (électro-aimant).

LP 8971 E-LH-AUT(C)

- Same as LP 8971 E-AUT, but with large hook (Chinese).
- Las mismas características que le LP 8971 E-AUT, pero con garfio grande (Chino).
- Baugleich mit LP 8971 E-AUT, jedoch mit großem Greifer (Chinesisch).
- Identique à la LP 8971 E-AUT, équipée avec crochet grande (Chinois).

LP 8974 E-AUT

- Double needle postbed machine, driven by HMC built-in mini servo motor, with wheel feed and top driven roller presser (no needle feed) and equipped with standard hooks, thread trimming device, automatic back tack and presser foot lift (all electric). Standard needle gauge 2,0 mm.
- Máquina de dos agujas, columna con mini motor HMC integrado, con arrastre por diente y ruleta accionada (sin avance de aguja). Equipada con garfio y standard y con corta-hilos, remate y alza-prensatelas (eléctrico). Distancia de agujas 2,0 mm.
- Máquina de columna de 2 agulhas, motor integrado na cabeça HMC, roletos acionados, (sem agulha acompanhante), lançadeira pequena. Equipada com corte linha, remate automático, levantamento calcador (tudo electrico)
- Zweinadel Säulenmaschine mit eingebautem HMC mini servo motor, mit Rad-Untertransport und von oben angetriebenem Rollfuß (kein Nadeltransport). Ausgestattet mit normalem Greifern, Fadenabschneider, automatischer Verriegelung und Presserfußlüftung (elektrisch). Standard Nadelabstand ist 2,0 mm.
- Machine pilier, 2 aiguilles, avec mini moteur servo intégré HMC, double entraînement par griffe et pied à roulette (pas d'entraînement d'aiguille) et crochet standard. La machine est équipée d'un dispositif coupe fil, des arrêts automatiques et relevage du pied presseur (électro-aimant). Écartement d'aiguille standard 2,0 mm. 1

TECHNICAL SPECIFICATIONS

MACHINE SPEED
max 2500 spm

OILING SYSTEM
Fully automatic

FEED TYPE
needle and wheel feed
top driven roller presser

No needle feed on the
LP 8974

STITCH LENGTH
max 7 mm

PRESSER FOOT LIFT
by hand: 7 mm
by knee: 14 mm
automatic: 14 mm

NEEDLE TYPE
134 LR

DOUBLE NEEDLE TYPE
Optional gauges:
1,8 mm, 2,2 mm, 2,4 mm

Global LP 2970 Series SINGLE OR DOUBLE NEEDLE POST BED MACHINES

Single and double needle postbed machines for the shoe industry. These unique machines are equipped with automatic or manual back tack on the lower and upper feed as well as on the needle feed. These machines are easy to maintain and very flexible to operate.

							(mm)			
							max.			
LP2971	•		•	•		•	12	•	•	•
LP2974		•	•		•	•	12	•	•	•

	Material	- Nm	- Nm	- System			Stitches / min.		
					(mm)	(mm)	(mm ⁻¹)	(mm)	(mm)
LP 2971			Standard			max.	max.		
E1	L	70 - 80	80	134 LR	1,4	4	3000	0,6	35
E2	M	90 - 110	90	134 LR	1,8	5	2500	0,6	35
E3	H	120 - 160	120	134 LR	2,4	7	2000	1,2	35
E17	M	90 - 110	90	134 LR	1,8	5	2500	1,2	25
E19	M	90 - 110	90	134 LR	1,8	5	2500	0,6	25
E34	L	70 - 80	80	134 LR	1,4	4	3000	-	35
E35	M	90 - 110	90	134 LR	1,8	5	2500	-	35

	Material	- Nm	- Nm	- System			Stitches / min.		
					(mm)	(mm)	(mm ⁻¹)	(mm)	(mm)
LP 2974			Standard				max.	max.	
WITHOUT NEEDLE FEED			Standard		Standard		max.	max.	
E55/1,6-2,0	M	90 - 110	90	134 KCLR	1,6 - 2,0	2,0	5	2500	0,6
E56/2,0-2,4	M	90 - 110	90	134 KCLR	2,0 - 2,4	2,0	5	2500	0,6
E57/2,0-2,4	H	120 - 140	120	134 KCLR	2,0 - 2,4	2,3	7	2500	0,6

	Material	- Nm	- Nm	- System			Stitches / min.		
					(mm)	(mm)	(mm ⁻¹)	(mm ⁻¹)	(mm)
LP 2974			Standard				max.	max.	
WITH NEEDLE FEED			Standard		Standard		max.	max.	
E8/1,2	L	70 - 80	80	134 KCLR	1,2	1,5	4	3000	0,6
E9/1,6	L	70 - 80	80	134 KCLR	1,6	1,5	4	3000	0,6
E10/2,0	L	70 - 80	80	134 KCLR	2,0	1,5	4	3000	0,6
E11/1,6	M	90 - 110	90	134 KCLR	1,6	1,5	4	2500	0,6
E12/2,0	M	90 - 110	90	134 KCLR	2,0	1,5	4	2500	0,6
E13/2,4	M	90 - 110	90	134 KCLR	2,4	1,5	5	2500	0,6
E14/2,4	H	120 - 160	120	134 LR	2,0	2,3	4	2000	1,2
E15/2,4	H	120 - 160	120	134 LR	2,4	2,3	5	2000	1,2
E16/3,2	H	120 - 160	120	134 LR	3,2	2,3	5	2000	1,2
E18/1,6	M	90 - 110	90	134 KCLR	1,6	1,5	4	2500	1,2
E20/2,0	M	90 - 110	90	134 KCLR	2,0	2,0	5	2500	0,6
E21/2,4	M	90 - 110	90	134 KCLR	2,4	2,0	5	2500	0,6
E30/1,6	M	90 - 110	90	134 KCLR	1,6	1,5	4	2500	1,2
E50/3,6	H	120 - 160	120	134 LR	3,6	2,3	5	2000	1,2
E54/2,0	M	90 - 110	90	134 KCLR	2,0	1,5	4	2500	1,2

L = Light weight material - M = Medium weight material - H = Heavy weight material



LP 2974 LH-AUT

Global LP 2970 Series

SINGLE OR DOUBLE NEEDLE LOCKSTITCH POST BED MACHINES FOR STITCHING OPERATIONS IN THE SHOE PRODUCTION

LP 2971 LH-AUT

Single needle lockstitch post bed machine with wheel feed, needle feed, driven roller presser and large hook. The machine is equipped with automatic thread trimmer, automatic back tacking, and presser foot lift.

Máquina de columna, 1 aguja, arrastre por rueda, aguja y ruleta accionada. Equipada con garfi o grande, corta hilos, remate y alza-prensateles manual y automáticos. Equipada para coser calzado en material ligero, medio y pesado.

Einnadel Säulemaschine mit Radtransport, Nadeltransport und oben angetriebenem Rollfuss. Ausgestattet mit grossem Greifer, Fadenabschneider, manuelle und automatischer Verriegelung und Presserfusslüftung. Diese Maschine ist geeignet für das Nähen von leichte, mittelschwere und schwere Schuhen.

Machine pilier avec entraînement par roué inférieur, aiguille et roué supérieur. Équipée avec crochet grande capacité, coupe fi l, point d'arrêt manuel et automatique, relevage automatique du pied. La machine est prévue pour coudre les chaussures en matière légère, moyenne et lourde.

LP 2974 LH-AUT

Double needle lockstitch post bed machine with wheel feed, driven roller presser and large hooks. Standard needle gauge 2,0 mm. The machine is equipped with automatic thread trimmer, automatic back tacking, and presser foot lift. It's easy to convert this machine into a needle feed machine.

Máquina de columna doble aguja, arrastre por rueda y ruleta accionada. Equipada con garfi os grandes, corta hilos y remate y alza-prensateles manual y automático. Distancia agujas estándar 2,0 mm. Se puede convertir facilmente en arrastre por aguja. Equipada para coser calzado material ligero, medio y pesado.

Zweinnadel Säulemaschine mit Radtransport und oben angetriebenem Rollfuss. Ausgestattet mit grossem Greifer, Fadenabschneider, manuelle und automatischer Verriegelung und Presserfusslüftung. Standard Nadelabstand 2,0 mm. Diese Maschine ist einfach umzubauen nach Nadeltransport. Dieser Maschine ist geeignet für das Nähen von leichte, mittelschwere und schwere Schuhen.

Machine pilier 2 aiguilles avec entraînement par roué inférieur et supérieur. Équipée avec crochet grande capacité, coupe fi l, point d'arrêt manuel et automatique, relevage automatique du pied. Ecartement standard des aiguilles de 2,0 mm. La machine est facilement transformable en version avec entraînement d'aiguille. La machine est prévue pour coudre les chaussures en matière légère, moyenne et lourde.

TECHNICAL SPECIFICATIONS

MACHINE SPEED
max 3000 spm

OILING SYSTEM
fully automatic

FEED TYPE
reversible needle feed,
top driven roller and wheel feed.
(no needle feed on LP 2974)

STITCH LENGTH
single needle : max 7 mm
double needle : max 5 mm

NEEDLE TYPE
134 LR, 134 KKLR or
134-35 LR



Global LP 2971 LH-NP-AUT POSTBED SHOE MACHINE WITH LEFT POST

LP 2971 LH-NP-AUT

- High speed single needle postbed machine with large hook and reversible top driven roller (35 mm \emptyset), wheel and needle feed. The machine is equipped with automatic thread trimmer, back tack and presser foot lift. This newly designed machine has a small left post to make it suitable for easy sewing on children's shoes.
- Máquina de calzado 1 aguja de alta velocidad, garfio grande con arrastre por ruleta accionada (35 mm \emptyset) con retroceso. La máquina está equipada con cortahilos, alzaprensatelas y retroceso automáticos. Esta máquina de novedoso diseño cuenta con un poste pequeño ala izquierda que la hace adecuada para el fácil cosido de zapatos para niños.
- Einnadel, Säulenmaschine mit großem Greifer. Die Hochleistungsmaschine verfügt über Unter, Nadel und Rollenobertransport (35 mm \emptyset) und ist mit Fadenabschneider, Verrieglungsautomatik und Nähfußlüftung ausgestattet. Das neue Design und die schmale linker Säule ermöglicht ein perfektes nähen auch im Bereich Kinderschuhe.
- Máquina de Coluna de 1 agulha de alta-velocidade, lançadeira grande, transporte triplo por rodízio superior (35 mm \emptyset), inferior e agulha. A máquina é equipada com corta-fio, retrocesso e levantamento do calçador automático. Este novo modelo de máquina têm a coluna estreita esquerda para facilitar a costura de calçados infantis.
- Machine pilier rapide, une aiguille avec crochet grande capacité et entraînement réversible par roue supérieure (35 mm \emptyset), roue inférieure et aiguille. La machine est équipée d'une coupe fil automatique, arrêts et relevage du pied automatiques. Cette nouvelle machine est Dotée d'un pilier gauche étroit particulièrement adapté pour une couture facile des chaussures d'enfants.

TECHNICAL SPECIFICATIONS

MACHINE SPEED
up to 3000 spm

NUMBER OF NEEDLES
1

HOOK TYPE
Large hook

STITCH LENGTH
up to 7 mm

NEEDLE TYPE
134 LR
(standard needle size 80)

BED TYPE
Postbed (left narrow post)

POST-CIRCUMFERENCE
176 mm

Material	- Nm	- System				
•L	70-80	134 LR	1.2	4	0,6 mm	35
M	90-110	134 LR	1.5	5	0,6 mm	35
M/H	120-140	134 LR	2.0	7	0,6 mm	35
H	140-160	134 LR	2.4	7	1,2 mm	35

L = Light weight material – M = Medium weight material – H = Heavy weight material
M/H = Medium-Heavy weight material • = Standard equipment



Global LP 2974 OS ORNAMENTAL STITCHING POSTBED MACHINE

LP 2974 OS

- Programmable ornamental stitching double needle postbed machine with large hooks, automatic thread trimmer, automatic back tacking and presser foot lift, which can carry out functional and decorative seams on shoes, suitcases, and bags. This machine is delivered with 16, single- and double-needle decorative stitch patterns, to sew 32 different patterns. Custom made patterns on request. Needle distance 3,2 mm.
- Máquina de poste, 2 agujas de puntada decorativa programable con ganchos grande, corta-hilos, remate y alza-prensatelas automáticas. Para trabajos decorativos en calzado, maletas y bolsos. La máquina se entrega con 16 patrones en 1 aguja y 2 agujas teniendo así 32 patrones distintos. A petición se entregar con patrones a medida. Distancia de agujas 3,2mm.
- Programmierbaren 2 Nadel Zierstich - Säulenmaschine (drehende Nadelstange) mit grossen Greifern, Fadenabschneider Verriegelung und Fusslüftung. Für funktionelle und Zierstiche an Schuhen, Koffern und Taschen. Die Maschine wird mit 32 Programmen geliefert, davon 16 2-Nadelprogramme und 16 1-Nadelprogramme. Auf Anfrage können wir auch Programme nach Wunsch erstellen. Nadelabstand: 3,2 mm
- Machine pilier 2 aiguilles à couture ornemental avec crochets de grandes capacités. Coupe fil, points d'arrêts et relevage du pied automatiques. Permet d'effectuer des coutures fonctionnelles et décoratives sur des chaussures, des valises et des sacs. Cette machine est livrée avec 16 motifs de points décoratifs simple et double-aiguille, pour coudre 32 modèles différents. Motif personnel réalisable sur demande. Écartement des aiguilles de 3,2 mm.

TECHNICAL SPECIFICATIONS

MACHINE SPEED
max 800 spm

OILING SYSTEM
fully automatic

FEED TYPE
top driven roller and wheel feed.

STITCH LENGTH
max 4 mm

NEEDLE TYPE
134-35 LR

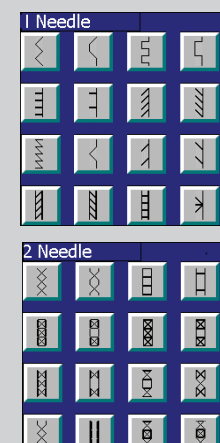



LP 9941 R

Global LP 9940 Series

ECONOMICAL DROP FEED POSTBED MACHINES WITH REVERSE

LP 9941 R

Single needle economical postbed machine with reversible drop feed, needle feed and roller presser foot for sewing medium materials. Stitch length 4 mm.

Máquina de columna económica, de una aguja con arrastre por aguja y diente y con ruleta para materiales medios pesados. Largo de puntada 4 mm.

Einnadel-Säulenmaschine mit Untertransport und Rollfuß, rückwärtsnähend für mittelschweres Material. Stichtlänge 4 mm.

Machine pilier économique à une aiguille - marche arrière - pied à roulette - destinée à la couture sur article d'épaisseur moyenne. Longueur de point 4 mm.

LP 9942 R

Double needle economical postbed machine with reversible drop feed, needle feed and roller Presser foot for sewing medium materials. Standard needle gauge 2,4 mm. Stitch length 4 mm.

Máquina de columna económica, de dos agujas con retroceso y ruleta para materiales medios pesados. Distancia de agujas 2,4 mm. Largo de puntada 4 mm.

Zweinnadel- Säulenmaschine mit umschaltbarem Transport und Rollfuß, für mittelschweres Material. Standard Nadelabstand 2,4 mm. Stichtlänge 4 mm.

Machine pilier économique à deux aiguilles - marche arrière - pied à roulette - destinée à la couture sur article d'épaisseur moyenne. Écartement standard 2,4 mm. Longueur de point 4 mm.

TECHNICAL SPECIFICATIONS

MACHINE SPEED
max 2400 spm

OILING SYSTEM
automatic

FEED TYPE
drop feed and needle feed

STITCH LENGTH
max 4 mm

NEEDLE TYPE
134 LR

NEEDLE GAUGE
9942 R standard 2,4 mm



Global LP 9970 Series

SHOE PRODUCTION MACHINES

LP 9971

- Single needle postbed machine with reversible top driven roller, wheel and needle feed with standard hook.
- Máquina columna de una agujas con arrastre por ruleta accionada, agujas acompañantes y dientes circulares con retroceso.
- Einnadel Säulenmaschine mit oben angetriebenem Rollfuß, Rad-Untertransport- und Nadeltransport, mit normalem Greifer.
- Machine pilier à une aiguille - marche arrière entraînement par griffe, aiguille et pied à roulette - crochet standard.

LP 9971 C

- Same as LP 9971, but with Chinese hook.
- Las mismas características que le LP 9971, pero con garfio chino.
- Baugleich mit LP 9971, jedoch mit Chinesisch Greifer.
- Identique à la LP 9971, mais avec crochet chinois.

LP 9974

- Double needle postbed machine with wheel feed and top driven roller presser (no needle feed) and equipped with standard hooks. Standard needle gauge 2,4 mm.
- Máquina de dos agujas, columna con arrastre por diente y ruleta accionada(sin avance de aguja). Equipada con garfio standard. Distancia de agujas 2,4 mm.
- Zweinadel Säulenmaschine mit Rad-Untertransport und von oben angetriebenem Rollfuß (kein Nadeltransport). Ausgestattet mit normalem Greifern. Standard Nadelabstand ist 2,4 mm.
- Machine pilier, 2 aiguilles, double entraînement par griffe et pied à roulette (pas d'entraînement d'aiguille) et crochet standard. Écartement d'aiguille standard 2,4 mm.

LP 9974 C

- Same as LP 9974, but with Chinese hook.
- Las mismas características que le LP 9974, pero con garfio chino.
- Baugleich mit LP 9974, jedoch mit Chinesisch Greifer.
- Identique à la LP 9974, mais avec crochet chinois.

TECHNICAL SPECIFICATIONS

MACHINE SPEED
max 3000 spm

OILING SYSTEM
Manual

FEED TYPE
needle feed, wheel feed and top driven roller presser (no needle feed on the LP9974)

STITCH LENGTH
LP 9971: 1,3 - 7 mm
LP 9974: 1,3 - 4,8 mm

PRESSER FOOT LIFT
by hand 7 mm
by knee 14 mm

NEEDLE TYPE
134 LR

NOTE:
No electric or pneumatic presser foot lifter available



LP 9916



LP 9916

Global LP 9915/9916

SUPER HIGH POSTBED MACHINES WITH WALKING FOOT

LP 9915 L

- Super high postbed machine (post is 45 cm high) with walking foot and standard hook. Model LP 9915 L has the hook on the left side of the needle. Machine is designed to sew boots and bags.
- Máquina de columna con poste extra largo (altura 45 cm), triple arrastre y garfio estándar. El modelo LP 9915 L tiene el garfio a la izquierda de la aguja. La máquina esta diseñada para coser botas y bolsos.
- Extra hohe Säulenmaschine (Säulenhöhe 45 cm) mit Dreifachtransport und standard Greifer. Model LP 9915 L hat den Greifer an den linken Seite der Nadel. Die Maschine wurde entwickelt zum nähen von Stiefeln und Taschen.
- Machine grand pilier (hauteur de 45 cm) avec triple entraînement et crochet standard. Sur la version LP 9915 L, le crochet est à gauche de l'aiguille. Machine recommandée pour les fabrications de bottes et sacs.

LP 9915 R

- Same as above, but with the hook on the right side of the needle.
- Las mismas características que la anterior, pero con el garfio a la derecha de la aguja.
- Baugleich mit LP 9915 L, jedoch mit den Greifer an den rechten Seite der Nadel.
- Identique à la version ci-dessus, mais avec crochet à droite de l'aiguille.

LP 9916

- Super high 2 needle postbed machine (post is 45 cm high) with walking foot and standard hooks. Machine is fully automatic lubricated and designed to sew boots and bags. Available needle distance 4 mm and 8 mm. Please note: Machine with needle distance of 4 mm is no stock item, but can be ordered upon request.
- Máquina, de dos agujas, de columna con poste extra largo (altura 45 cm), triple arrastre y garfio estándar. Lubricación automático y diseñada para coser botas y bolsos. Disponible con distancia de agujas a 4mm. y 8mm. Nota: la máquina con distancia de agujas a 4mm. solo será pedido a petición.
- Extra hohe 2 nadel Säulenmaschine (Säulenhöhe 45 cm) mit Dreifachtransport und standard Greifer. Vollautomatische Schmierung. Geeignet zum Nähen von Stiefeln und Taschen. Nadelabstände: 4mm und 8 mm. Die 4mm Version ist nur auf Bestellung erhältlich und ist keine Lagerware.
- Machine pilier 2 aiguilles super haute (hauteur de 45 cm) triple entraînement et crochets standards Lubrification automatique et recommandé pour couture sur bottes et sacs. Écartement d'aiguilles disponible en 4 et 8 mm. L'écartement de 4 mm est disponible uniquement sur commande.

TECHNICAL SPECIFICATIONS

MACHINE SPEED
max 1600 spm

OILING SYSTEM
Fully automatic

STITCH LENGTH
max 6 mm

PRESSER FOOT LIFT
by hand max 8 mm
by pedal max 15 mm

NEEDLE TYPE
135 x 17



LP 1768-2 SNB AUT



Optional foxing operation



LP 1768-2 AUT

Global LP 1768 Series HIGH SPEED WALKING FOOT POSTBEDMACHINES

LP 1768 AUT

- Single needle walking foot postbed machine with thread trimmer, automatic back tack, presser foot lift, quick stroke adjustment for assembly and topstitching operations in home upholstery, car upholstery and leather.
- Máquina de columna de una aguja, triple arrastre para trabajos extra pesados con corta-hilos eléctrico.
- Einnadel Säulenmaschine mit Dreifachtransport, Fadenabschneider, automatischer Verriegelung, Presserfußlüfter, Hubschnellverstellung für Montage- und Stepparbeiten im Wohnpolster, Autopolster und Lederbereich.
- Machine pilier une aiguille avec entraînement triple, coupe-fil, arrêt de automatique, relevage de pied presseur, réglage rapide d'élévation pour travaux de montage et de surpiquage decapitonnages de mobilier, d'automobile et de cuir.

LP 1768-2 AUT

- Double needle walking foot postbed machine with thread trimmer, automatic back tack, presser foot lift, quick stroke adjustment and integrated second stitch length for assembly and topstitching operations in home upholstery, car upholstery and leather. Standard needle gauge 8 mm.
- Máquina de columna de dos agujas, triple arrastre para trabajos extra pesados con corta-hilos eléctrico. Espesor de la aguja estándar 8mm.
- Zweinadel Säulenmaschine mit Dreifachtransport, Fadenabschneider, automatischer Verriegelung, presserfußlüfter, Hubschnellverstellung und Stepparbeiten im Wohnpolster, Autopolster und Lederbereich. Standard Nadelabstand 8 mm.
- Machine pilier deux aiguilles avec entraînement triple, coupe-fil, arrêt de automatique, relevage de pied presseur, réglage rapide d'élévation pour travaux de montage et de surpiquage decapitonnages de mobilier, d'automobile et de cuir. Écartement d'aiguilles standard de 8 mm.

LP 1768-2 SNB AUT

- Same as LP 1768-2 AUT, but with pneumatic disengageable needle bars.
- La misma que la LP 1768-2 AUT, pero equipada agujas desembragable neumático.
- Baugleich mit LP 1768-2 AUT, jedoch mit pneumatische ausschaltbarer Nadeln.
- Identique à la LP 1768-2 AUT, mais avec aiguilles escamotables à commande pneumatique.

TECHNICAL SPECIFICATIONS

MACHINE SPEED
max 2400 spm

STITCH LENGTH
max 9 mm

PRESSER FOOT LIFT
max 16 mm

INNER PRESSER FOOT ALTERNATION
1 - 7 mm

THREAD TRIMMER
Electric

BACK TACK AND PRESSER FOOT LIFT
Pneumatic

NEEDLE TYPE
134-35

DOUBLE NEEDLE TYPE
Optional gauges
6,0 - 6,4 - 10 - 12 mm

Special gauge set 2,0 or 3,2 mm
for foxing operation

Dürkopp Adler 838 M-type Series

Postbed machines with bottom feed and driven roller presser foot are especially designed for all kinds of leather, textile materials and sport shoes, particularly for sewing thick threads. Efficient combination of feeding system guarantees stable stitch length and performance. Machines are equipped with electropneumatic seam backtacking and presser foot lift, enabling to sew thick materials easily.

838-170522	•		•	•	•	max 12 mm	•	•	•
838-270522	–	•	•	•	•	max 12 mm	•	•	•

	Material	- Nm	- System			Stitches/min		
838-E1	M	120 - 160	134 LR	2,0 mm	8	2000	1,5 mm	35
838-E2	H	180 - 230	134 LR	2,8 mm	8	1600	1,5 mm	35

	Material	- Nm				Stitches/min		
838-E3/1,6	H	120 - 180	1,6 mm	2,5 mm	max 8 mm	2000	1,5 mm	35
838-E4/2,0	H	120 - 180	2,0 mm	2,5 mm	max 8 mm	2000	1,5 mm	35
838-E5/2,4	H	120 - 180	2,4 mm	2,5 mm	max 8 mm	2000	1,5 mm	35
838-E6/3,2	H	120 - 180	3,2 mm	2,5 mm	max 8 mm	2000	1,5 mm	35

- L = Light weight material
- M = Medium weight material
- H = Heavy weight material
- = Standard equipment

Special features

- Highest precision on stitch locking even during sewing speed changes
- Automatic bobbin winder with start up function
- Pneumatic switchable second thread tension for optimised sewing results
- Low noise and vibration
- The powerful and effective feeding system with bottom feed and driven roller presser guarantees excellent material feed when processing different material thicknesses
- Integrated second stitch length for quick stitch length change
- Electropneumatic presser foot lifting and backtacking enabling setting of high pressure on foot for sewing of strong materials
- Large vertical hook
- Simple needle guard adjustment by screw
- Device for controlling the difference between the upper and bottom feed from +10 % to –10 % (optional)
- Fast hook exchange
- Needle change without tools (single needle machines)
- New lubricating system with central oil tank and oil pump
- Roller presser setting by operator without tools (optional)
- Integrated built-in motor to save energy, easy maintenance
- Switch button for setting a reduced stitch, e.g. at material borders
- Fully integrated solenoids no compressed air required
- Integrated keypad with ergonomically arranged sensor key
- Easy maintenance and access, only a few tools needed



838-170522

838 M-TYPE SERIES

INDUSTRIAL SEWING MACHINES

Dürkopp Adler 838 M-type Series POSTBED SHOE PRODUCTION MACHINES

838-170522

- Single needle lockstitch postbed machine (right post) with driven roller presser and bottom feed, with electromagnetic thread trimmer, integrated 2-stitch length control, electro-pneumatic seam back tack and presser foot lift with large vertical two piece hook, safety clutch, presser foot height of 12 mm, stitch length up to 8 mm, maximum sewing speed 2.000 stitches/min.
- Máquina de poste (derecha de la aguja), 1 aguja con arrastre por rodilla superior y diente interior. Equipada con gancho grande sobre eje vertical de dos piezas, corta-hilos electro-magnético, 2 largos de puntada integrado, remate y alza-prensatelas neumático. Recorrido alza-prensatelas 12 mm. Máxima velocidad 2.000 puntadas por minuto y largo de puntada hasta 8mm.
- Einnadel-Doppelsteppstich Säulenmaschine (rechtständige Säule) mit angetriebenem Rollfuß und Untertransport, mit elektromagnetischem Fadenabschneider, integrierter zweiter Stichlänge, elektropneumatischer Nahtverriegelung und Nähfußlüftung, mit großem zweiteiligen Vertikalgreifer, Sicherheitskupplung, einer Nähfußhöhe von 12 mm, einer Stichlänge von max 8 mm und einer max. Nähgeschwindigkeit von 2000 Stichen/Min.
- Machine à coudre à colonne gauche, une aiguille, point noué, avec pied presseur à roulette motorisée et entraînement inférieur, avec coupe-fil électromagnétique, deuxième longueur de points intégrée, dispositif de point arrière et lève-pied électropneumatiques, crochet vertical surdimensionné en deux parties, avec accouplement de sécurité, hauteur de levée pied de 12 mm, longueur de point jusqu'à 8 mm et vitesse max. de couture de 2000 points/min.

838-270522

- Double needle lockstitch postbed machine with driven roller presser and bottom feed, with electromagnetic thread trimmer, integrated 2-stitch length, electro-pneumatic seam lift back tacking and presser foot, with large vertical two piece hooks, safety clutch, presser foot height of 12 mm, stitch length up to 8 mm, max. sewing speed 2.000 stitches/min.
- Máquina de poste (derecha de la aguja), 2 agujas con arrastre por rodilla superior y diente interior. Equipada con gancho grande sobre eje vertical de dos piezas, corta-hilos electro-magnético, 2 largos de puntada integrado, remate y alza-prensatelas neumático. Recorrido alza-prensatelas 12 mm. Máxima velocidad 2.000 puntadas por minuto y largo de puntada hasta 8mm.
- Zweinadel-Doppelsteppstich Säulenmaschine mit angetriebenem Rollfuß und Untertransport, mit elektromagnetischem Fadenabschneider, integrierter zweiter Stichlänge, elektropneumatischer Nahtverriegelung und Nähfußlüftung, mit großen zweiteiligen Vertikalgreifern, Sicherheitskupplung, einer Nähfußhöhe von 12 mm, einer Stichlänge von max 8 mm und einer max. Nähgeschwindigkeit von 2000 Stichen/Min.
- Machine à coudre, deux aiguilles, point noué, avec pied presseur à roulette motorisée et entraînement inférieur, avec coupe-fil électromagnétique, deuxième longueur de points intégrée, dispositif de point arrière et lève-pied électropneumatiques, crochets verticaux surdimensionnés en deux parties, avec accouplement de sécurité, hauteur de levée pied de 12 mm, longueur de point jusqu'à 8 mm et vitesse max. de couture de 2000 points/min.

TECHNICAL SPECIFICATIONS

MACHINE SPEED
max 2000 spm

OILING SYSTEM
Fully automatic

STITCH LENGTH
max 8 mm

FEED TYPE
top driven roller and
bottom feed

NEEDLE TYPE
134 LR

ROLLER PRESSER
standard 35 mm ø

NOTE
To use this machine you need
an EFKA motor

Dürkopp Adler 884 M-type Series

Single needle postbed machines for the shoe industry. These unique machines are equipped with automatic or manual back tack on the lower and upper feed as well as on the needle feed.

These machines are easy to maintain and very flexible to operate.

884-150050-M	•	•	•	•	max 12 mm	•	–	–	C=280 D=300
884-150152-M	•	•	•	•	max 12 mm	•	•	•	C=280 D=300

			Material	- Nm	- Nm	- System			Stitches/min			
884-E1	•		L	70 - 80	80	134 LR	1,5 mm	4	3000	0,6 mm		35
884-E2	•		M	90 - 110	90	134 LR	1,8 mm	5	2500	0,6 mm		35
884-E3	•		L	70 - 80	80	134 LR	1,5 mm	4	3000		•	35
884-E4	•		M	90 - 110	90	134 LR	1,8 mm	5	2500		•	35

L = Light weight material M = Medium weight material H = Heavy weight material • = Standard equipment

Special features

- Small diameter of hook post (post dimensions are 170 x 43 x 49,2 mm) enables to use machine for difficult operations on small-sized shoes and other jobs
- Highest precision on stitch locking even during sewing speed changes
- Automatic bobbin winder with start up function
- Manual switchable second thread tension for optimized sewing results (884-150050)
- Low noise and vibration
- The powerful and effective feeding system with wheel feed, needle feed and driven roller presser guarantees excellent material feed when processing different material thicknesses
- Standard hook with 22 mm bobbin
- Simple needle guard adjustment by screw
- Device for controlling the difference between the upper and bottom feed from +10 % to –10 % (optional)
- Fast dismantling of hook
- Needle change without tools
- Lubricating system with central oil tank and oil pump
- Roller presser setting by operator without tools (optional)
- Integrated built-in motor to save energy, easy maintenance
- Switch button for setting a reduced stitch, e.g. at material borders and integrated keypad with ergonomically arranged sensor key (advanced functions optional for 884-150152)
- Fully integrated solenoids (884-150152), no compressed air required
- Integrated LED sewing light (optional)
- Easy maintenance and access, only a few tools needed



Dürkopp Adler 884 M-type Series POSTBED SHOE PRODUCTION MACHINES

884-150050

Single needle lockstitch, direct drive, post bed machine with wheel feed, needle feed and driven roller presser, for stitching operations in the shoe production with slim post. This post bed machine is perfectly suited for the production of small-sized shoe uppers.

Máquina poste de 1 aguja con avance de peine giratorio, aguja y ruleta accionada, de poste estrecha para operaciones en la producción del calzado. La máquina de poste se presta perfectamente para la producción del parte superior de calzado chico.

Einnadel, Direct Drive Säulenmaschine Mit angetriebenem Rollfuss Nadel – und Schiebradtransport, für Näharbeiten in der Schuhproduktion auf einer dünnen Säule. Die Maschine ist perfekt geeignet für Schaftproduktion in kleinen Größen und Kinderschuhe.

Machine pilier point noué 1 aiguille, moteur direct, avec entraînement par roue, entraînement par aiguille et par pied à roulette, pour opérations de couture en production chaussure avec pilier fin. Cette machine pilier est parfaitement adaptée pour la production de tige de chaussure de petites tailles.

884-150152

Same as 884-150050, but equipped with automatic thread trimmer, automatic backtacking, and presser foot lift.

Las mismas características que la 884-150050, pero con corta-hilos automático, remate automático y alza- prensatelas.

Baugleich mit 884-150050, aber mit automatischem Fadenabschneider, automatischer Verriegelung und Nähfußlüftung ausgestattet.

Identique au modèle 884-150050, mais avec coupe-fils automatique, d'un bridage automatique de la couture par arrêt et d'un releveur du pied presseur.

TECHNICAL SPECIFICATIONS

MACHINE SPEED
max 3000 spm

OILING SYSTEM
fully automatic

STITCH LENGTH
max 5 mm

FEED TYPE
reversible needle feed
top driven roller and wheel feed

NEEDLE TYPE
134 LR

ROLLER PRESSER
standard 35 mm ø

Dürkopp Adler 888 M-type Series

Single and double needle postbed machines for the shoe industry. These unique machines are equipped with automatic or manual back tack on the lower and upper feed as well as on the needle feed. These machines are easy to maintain and very flexible to operate.

888-160020	•	–	•	•	•	–	max 12 mm	•	–	–	–
888-160122	•	–	•	•	•	–	max 12 mm	•	•	•	•
888-160152	•	–	•	•	–	•	max 12 mm	•	•	•	•
888-260020	–	•	•	•	•	–	max 12 mm	•	–	–	–
888-260122	–	•	•	•	•	–	max 12 mm	•	•	•	•

	Material	- Nm	- System					Stitches/min		
888-E1	L	70 - 80	134 LR	•	–	1,4 mm	4	3000	0,6 mm	35
888-E2	M	90 - 110	134 LR	•	–	1,8 mm	5	2500	0,6 mm	35
888-E3	H	120 - 160	134 LR	•	–	2,4 mm	7	2000	1,2 mm	35
888-E23	L	70 - 80	134 LR	–	•	1,4 mm	4	3000	0,6 mm	35
888-E24	M	90 - 110	134 LR	–	•	1,8 mm	5	2500	0,6 mm	35
888-E25	H	120 - 160	134 LR	–	•	2,4 mm	7	2000	1,2 mm	35

	Material	- Nm	- System				Stitches/min		
888-E8/1,2	L	70 - 80	134 LR	1,2 mm	1,5 mm	max 4 mm	3000	0,6 mm	35
888-E9/1,6	L	70 - 80	134 LR	1,6 mm	1,5 mm	max 4 mm	3000	0,6 mm	35
888-E10/2,0	L	70 - 80	134 LR	2,0 mm	1,5 mm	max 4 mm	3000	0,6 mm	35
888-E11/1,6	M	90 - 110	134 LR	1,6 mm	1,5 mm	max 4 mm	2500	0,6 mm	35
888-E12/2,0	M	90 - 110	134 LR	2,0 mm	1,5 mm	max 4 mm	2500	0,6 mm	35
888-E13/2,4	M	90 - 110	134 LR	2,4 mm	1,5 mm	max 5 mm	2500	0,6 mm	35
888-E14/2,0	H	120 - 160	134 LR	2,0 mm	2,3 mm	max 4 mm	2000	1,2 mm	35
888-E15/2,4	H	120 - 160	134 LR	2,4 mm	2,3 mm	max 5 mm	2000	1,2 mm	35
888-E16/3,2	H	120 - 160	134 LR	3,2 mm	2,3 mm	max 5 mm	2000	1,2 mm	35

L = Light weight material M = Medium weight material H = Heavy weight material • = Standard equipment

Special features

- Highest precision on stitch locking even during sewing speed changes
- Skip stitches at seam start after cutting can be influenced by movable needle plate inserts
- Low noise and vibration
- The powerful and effective feeding system with wheel feed, needle feed and driven roller presser guarantees excellent material feed when processing different material thicknesses
- Automatic bobbin winder with start up function
- Easy throat plate change without tools (single needle machines)
- An easy replacement of wheel feeder without tools (single-needle machines)
- Large vertical hook
- Simple needle guard adjustment by screw
- Device for controlling the difference between the upper and bottom feed from +10 % to –10 % (optional)
- Hook replacement without dismantling of bobbin case
- Needle change without tools (single needle machines)
- New lubricating system with central oil tank and oil pump
- Roller presser setting by operator without tools (optional)
- Integrated built-in motor to save energy, easy maintenance
- Switch button for setting a reduced stitch, e.g. at material borders
- Fully integrated solenoids no compressed air required
- Integrated keypad with ergonomically arranged sensor key



888-260122



888-260122

Dürkopp Adler 888 M-type Series POSTBED SHOE PRODUCTION MACHINES

888-160020

- Single needle lockstitch post bed machine with wheel feed, needle feed and driven roller presser and a maximum stitch length 7 mm.
- Máquina de columna, de doble pespunte, de una aguja con transporte de rueda corrediza y de aguja, pata rodante accionada, longitud máxima de puntada 7 mm.
- Einnadel-Doppelsteppstich Säulennähmaschine mit Schiebrad- und Nadeltransport und angetriebenem Rollfuß, maximale Stichlänge 7 mm.
- Machine à coudre à pilier à une aiguille à point de navette avec entraînement par roue et par aiguille et avec pied à roulette entraîné, longueur maximale du point 7 mm.

888-160122

- Same as 888-160020, but equipped with automatic thread trimmer, automatic backtacking, and presser foot lift.
- Las mismas características que la 888-160020, pero con corta-hilos automático, remate automático y alza- prensatelas.
- Baugleich mit 888-160020, aber mit automatischem Fadenabschneider, automatischer Verriegelung und Nähfußblüftung ausgestattet.
- Identique au modèle 888-160122, mais avec coupe-fils automatique, d'un bridage automatique de la couture par arrêt et d'un releveur du pied presseur.

888-160152

- Same as 888-160122, but equipped with small hook.
- Las mismas características que la 888-160122, pero con garfio pequeño.
- Baugleich mit 888-160122, aber mit kleinem Greifer.
- Identique au modèle 888-160122, mais avec crochet petit.

888-260020

- Double needle lockstitch post bed machine with wheel feed, needle feed and driven roller presser and a maximum stitch length 5 mm.
- Máquina de columna, de doble pespunte, de dos agujas con transporte de rueda corrediza y de aguja, pata rodante accionada, longitud máxima de puntada 5 mm.
- Zweinadel-Doppelsteppstich Säulennähmaschine mit Schiebrad- und Nadeltransport und angetriebenem Rollfuß, maximale Stichlänge 5 mm.
- Machine à coudre à pilier à deux aiguilles à point de navette avec entraînement par roue et par aiguille et avec pied à roulette entraîné, longueur maximale du point 5 mm

888-260122

- Same as 888-260020, but equipped with automatic thread trimmer, automatic backtacking, and presser foot lift.
- Las mismas características que la 888-260020, pero con corta-hilos automático, remate automático y alza- prensatelas.
- Baugleich mit 888-260020, aber mit automatischem Fadenabschneider, automatischer Verriegelung und Nähfußblüftung ausgestattet.
- Identique au modèle 888-260020, mais avec coupe-fils automatique, d'un bridage automatique de la couture par arrêt et d'un releveur du pied presseur.

TECHNICAL SPECIFICATIONS

MACHINE SPEED
max 3000 spm

OILING SYSTEM
fully automatic

STITCH LENGTH
Single needle max 7 mm
Double needle max 5 mm

FEED TYPE
reversible needle feed
top driven roller and wheel feed

NEEDLE TYPE
134 LR

ROLLER PRESSER
standard 35 mm ø

Dürkopp Adler 888 M-type Special Series

Single and double needle postbed machines for the shoe industry. These unique machines are equipped with automatic or manual back tack on the lower and upper feed as well as on the needle feed.

These machines are easy to maintain and very flexible to operate.

888-356020	•	•	•	•	•	•	•	•	•	•	•
888-356122	•	•	•	•	•	•	•	•	•	•	•
888-167122	•	•	•	•	•	•	•	•	•	•	•

	Material	- Nm	- System			Stitches/min				
888-E4	L	70 - 80	134 LR	1,2 mm	4 mm	3000	0,8 mm		0,6 mm	25
888-E5	M	90 - 110	134 LR	1,6 mm	5 mm	2500	1,0 mm		0,6 mm	25
888-E6	H	120 - 160	134 LR	1,8 mm	5 mm	2000	1,2 mm		0,6 mm	25
888-E7	H	120 - 160	134 LR	2,0 mm	5 mm	2000	1,5 mm		0,6 mm	25
888-E58	L	70 - 80	134 LR	1,2 mm	4 mm	2500		0,8 mm	0,6 mm	35
888-E59	M	90 - 120	134 LR	1,5 mm	5 mm	2000		1,2 mm	0,6 mm	35
888-E60	H	120 - 180	134 LR	2,0 mm	5 mm	2000		1,5 mm	0,6 mm	35

888-460522	•	•	•	•	•	•	•	•	•	•

	Material	- Nm	- System				Stitches/min		
888-E49/1,6	L	70 - 80	134-35 LR	1,6 mm	1,2 mm	max 4 mm	3000	0,6 mm	35
888-E44/2,0	M	70 - 80	134-35 LR	2,0 mm	2,0 mm	max 4 mm	3000	0,6 mm	35
888-E45/2,0	H	90 - 120	134-35 LR	2,0 mm	2,0 mm	max 5 mm	2500	0,6 mm	35
888-E46/2,4	L	90 - 120	134-35 LR	2,4 mm	2,0 mm	max 5 mm	2500	0,6 mm	35
888-E47/2,4	M	120 - 140	134-35 LR	2,4 mm	2,0 mm	max 5 mm	2000	0,6 mm	35
888-E48/3,2	H	120 - 160	134-35 LR	3,2 mm	2,3 mm	max 5 mm	2000	1,2 mm	35

L = Light weight material M = Medium weight material H = Heavy weight material • = Standard equipment

Special features

M-Type 888

for undertrimming

- Highest precision on stitch locking even during sewing speed changes
- Equipment for 4 different trimming margins
- Easy winding due to automatic bobbin winder with start up function
- Manual switchable second thread tension for optimised sewing results (ECO)
- Low noise and vibration

- The powerful and effective feeding system with wheel feed, needle feed and driven roller presser guarantees excellent material feed when processing different material thicknesses
- Increased productivity due to large vertical hook with high winding capacity
- Simple needle guard adjustment by screw

- Device for controlling the difference between the upper and bottom feed from +10 % to -10 %
- Fast hook exchange
- Needle change without tools (single needle machines)
- New lubricating system with central oil tank and oil pump

M-Type 888

With electro-pneumatic mechanism for disconnection of left or right needle

- Machine belongs to M-Type series having all advantages and features
- Independently disconnectable left/right needle
- Integrated 2nd stitch length and switchable thread tension
- Electro-pneumatic seam back-tacking and presser foot lift
- Ergonomical control elements



888-460522



888-167122



888- 356020

Dürkopp Adler 888 M-type Special Series POSTBED SHOE PRODUCTION MACHINES

888-356020

- Single needle lockstitch, post bed machine (left handed post) with large hook, lining trimmer and manual backtacking, with wheel feed, needle feed and top driven roller presser (also during backtacking), maximum stitch length 5 mm.
- Máquina de poste (izquierda de la aguja), 1 aguja con cuchilla de recortar, remate manual y arrastre por rodilla, peine circular y aguja (también en retroceso) con larga de puntada de 5mm.
- Einnadel-Doppelsteppstich Säulenmaschine (linksständige Säule) mit großem Greifer, Unterschneider und manueller Verriegelung, mit Schiebrad- und Nadeltransport und angetriebenem Rollfuß (auch während der Verriegelung), max. Stichlänge 5 mm.
- Machine à coudre à colonne gauche, une aiguille, point noué, avec crochet à grande capacité, recoupeur et arrêt de couture manuel, avec entraînement par roue et par aiguille et avec roulette motorisée (durant le point d'arrêt également), longueur maximale du point 5 mm.

888-356122

- Same as 888-356020, but with automatic thread trimmer, automatic back tack and presser foot lift.
- Mismas características que la 888-356020, pero con corta-hilos, remate y alza-prensateles automáticos y función de reducción de puntada.
- Baugleich mit 888-356020, aber mit automatischem Fadenabschneider, automatischer Verriegelung und Nähfußlüftung ausgestattet.
- Identique au modèle 888-356020, mais avec coupe-fils automatique, d'un bridage automatique de la couture par arrêt et d'un releveur du pied presseur.

888-167122

- Single needle lockstitch, post bed machine (right handed post) with wheel feed, needle feed, top driven roller presser. Machine is equipped with electric thread trimmer, presser foot lift, automatic back tack, motor driven oblique knife and large hook.
- Máquina de poste (izquierda de la aguja), 1 aguja con arrastre por diente circular, aguja y ruleta accionada. La máquina esta equipada con corta-hilos, remate, alza-prensateles eléctricos, recorte obliquo eléctrico y garfio grande.
- Einnadel-Doppelsteppstich-Säulenmaschine (linksständige Säule) mit Schiebrad- und Nadeltransport und angetriebenem Rollfuß. Der Maschine ist mit automatischem Fadenabschneider, automatischer Verriegelung, Nähfußlüftung, Motor angetriebene "oblique" Messer und großem Greifer ausgestattet.
- Machine pilier à gauche 1 aiguille - haute vitesse - entraînement par pied à roulette, aiguille et griffe circulaire à mouvement intermittent. Equipée avec coupe-fils électrique, relevage de pied, arrêt automatiques, couteau raseur commandé par moteur indépendant et crochet grande capacité.

888-460522

- Double needle lockstitch post bed machine with large hooks, for a professional performance of sewing operations on shoes and different leather articles. To avoid crossed seams at the corners, machine is equipped with electro-pneumatic mechanism for disconnection of left or right needle.
- Máquina de poste de 2 agujas con gancho grande, de uso profesional en calzado y otros artículos de cuero. La máquina esta equipada con mecanismo neumático para desembragar la aguja izquierda o derecha, para evitar costuras cruzadas.
- Zweinadel-Doppelsteppstich-Säulenmaschine (linksständige Säule) mit großem Greifer, eignet sich perfekt für einen professionellen Einsatz bei Näharbeiten an Schuhen und anderen Lederartikeln. Um Kreuznähte in den Ecken zu vermeiden ist die Maschine mit einem elektropneumatischen Mechanismus ausgestattet, der eine Abschaltung der linken oder rechten Nadel möglich macht.
- Machine à coudre à colonne, point noué, avec crochet à grande capacité, s'adapte à la perfection pour une mise en oeuvre professionnelle dans le cadre des coutures sur chaussures et autres articles en cuir. Afin d'éviter un croisement des coutures dans les angles, cette machine est équipée d'un mécanisme électropneumatique permettant de désactiver l'une des aiguilles droite ou gauche.

TECHNICAL SPECIFICATIONS

MACHINE SPEED
max 3000 spm

OILING SYSTEM
fully automatic

FEED TYPE
reversible needle feed
top driven roller and wheel feed

STITCH LENGTH
max 5 mm

NEEDLE TYPE
134 LR

Dürkopp Adler 887 M-type Series

These machines offer smooth sewing and a constant high stitch quality. Excellent stitch pattern and a constant and tight stitch formation is guaranteed by the optimized sewing. A new dimension of flexibility and functionality has been created! 887 machines are suitable to process most different seams easily and with constant stitch performance.

887-160020	•	•	•	•	–	max 12 mm	•	–	–
887-160122	•	•	•	•	–	max 12 mm	•	•	•
887-160040	•	•	•	–	•	max 12 mm	•	–	–
887-160142	•	•	•	–	•	max 12 mm	•	•	•

	Model	Material	- Nm	- System			Stitches/min	
887-E1	887 160020	L	70 - 80	134 LR	1,4 mm	4 mm	3000	35
887-E1	887 160122	L	70 - 80	134 LR	1,4 mm	4 mm	3000	35
887-E2	887 160020	M	90 - 110	134 LR	1,8 mm	5 mm	2500	35
887-E2	887 160040	M	90 - 110	134 LR	1,8 mm	5 mm	2500	35
887-E2	887 160122	M	90 - 110	134 LR	1,8 mm	5 mm	2500	35
887-E2	887 160142	M	90 - 110	134 LR	1,8 mm	5 mm	2500	35
887-E3	887 160020	H	120 - 160	134 LR	2,4 mm	7 mm	2000	35
887-E3	887 160040	H	120 - 160	134 LR	2,4 mm	7 mm	2000	35
887-E3	887 160122	H	120 - 160	134 LR	2,4 mm	7 mm	2000	35
887-E3	887 160142	H	120 - 160	134 LR	2,4 mm	7 mm	2000	35

	Material	- Nm	- System				Stitches/min		
887-260020	•	•	•	•	•	max 12 mm	•	–	–
887-260122	•	•	•	•	•	max 12 mm	•	•	•

	Material	- Nm	- System				Stitches/min		
E0887/1,2(1)	L	70 - 80	134 LR	1,2 mm	1,5 mm	4 mm	2500	0,6 mm	35
E0887/1,6(1)	L	70 - 80	134 LR	1,6 mm	1,5 mm	4 mm	2500	0,6 mm	35
E0887/2,0(1)	L	70 - 80	134 LR	2,0 mm	1,5 mm	4 mm	2500	0,6 mm	35
E0887/1,6(2)	M	90 - 120	134 LR	1,6 mm	1,5 mm	4 mm	2000	0,6 mm	35
E0887/2,0(2)	M	90 - 120	134 LR	2,0 mm	1,5 mm	4 mm	2000	0,6 mm	35
E0887/2,4(2)	M	90 - 120	134 LR	2,4 mm	1,5 mm	5 mm	2000	0,6 mm	35
E0887/2,0(3)	H	120 - 140	134 LR	2,0 mm	2,3 mm	4 mm	1600	1,2 mm	35
E0887/2,4(3)	H	120 - 140	134 LR	2,4 mm	2,3 mm	5 mm	1600	1,2 mm	35

L = Light weight material M = Medium weight material H = Heavy weight material • = Standard equipment

Special features

- 6 subclasses with highly efficient equipment features
- Excellent stitch pattern, constant and tight stitch formation even during sewing speed changes
- Sewing start-up can be influenced by the movable needle plate inserts
- Automatic bobbin winder with winding starting aid
- Manually switchable second thread tension for optimised sewing results
- Low noise and vibration
- The powerful and effective feeding system with wheel feed, needle feed and driven roller presser guarantees excellent material feed when processing different material thicknesses
- Feeding wheel with cross grooving for minimized marks on the fabrics
- Extra large XXL vertical hook with bobbin thread capacity increased by 70%, enabling to reduce the number of bobbin changes significantly
- Feeding wheel covered by rubber, for mark-free sewing (optional)
- Hook replacement without dismantling of bobbin case
- Needle change without tools
- New lubricating system with central oil tank and oil pump
- Extra fine setting of roller presser position
- Integrated built-in motor to save energy and for easy maintenance
- "Reduced-stitch" device for setting a short stitch e.g. at material edges by using switch button
- Fully integrated solenoids, no compressed air required
- Integrated keypad with ergonomically arranged sensor key
- Easy maintenance and access, only a few tools needed



887-160020

Dürkopp Adler 887 M-type Series FLATBED SHOE PRODUCTION MACHINES

887-160020

- Single needle lockstitch flat bed machine with wheel feed, needle feed and driven roller presser and a maximum stitch length of 7 mm.
- Máquina de placa plana de doble pespunte y una aguja con transporte de rueda corrediza y de aguja, pata rodante accionada, longitud máxima de puntada 7 mm.
- Einnadel-Doppelsteppstich-Flachbettmaschine mit Schiebrad und Nadeltransport und angetriebenem Rollfuß, maximale Stichtlänge 7 mm.
- Machine à coudre à base plate, une aiguille, point noué, pour piquage des chaussures, avec entraînement par roué et par aiguille et avec pied à roulette entraîné, longueur maximale du point 7 mm.

887-160122

- Same as 887-160020, but equipped with automatic thread trimmer, automatic back tack, and presser foot lift.
- Las mismas características que la 887-160020, pero con corta-hilos automático, remate automático y alza-prensatelas.
- Baugleich mit 887-160020, aber mit automatischem Fadenabschneider, automatischer Verriegelung und Nähfußlüftung ausgestattet.
- Identique au modèle 887-160020, mais avec coupe-fils automatique, d'un bridage automatique de la couture par arrêt et d'un releveur du pied presseur.

887-160040

- Single needle lockstitch flat bed machine with wheel feed, needle feed and driven roller presser and a maximum stitch length of 7 mm. Machine is equipped with extra large XXL hook with bobbin thread capacity increased by 70%, enabling to reduce the number of bobbin changes significantly.
- Máquina de placa plana de doble pespunte y una aguja con transporte de rueda corrediza y de aguja, pata rodante accionada, longitud máxima de puntada 7 mm. La máquina está equipada con un garfio vertical extra grande XXL que aumenta la capacidad de hilo en un 70% y así se reduce considerablemente el número de cambios de bobinas.
- Einnadel-Doppelsteppstich-Flachbettmaschine mit Schiebrad und Nadeltransport und angetriebenem Rollfuß, maximale Stichtlänge 7 mm. Die Maschine ist mit einem extra großen XXL Vertikalgreifer ausgestattet, der die Spulfadenkapazität um 70% steigert und somit die Anzahl an Spulwechseln erheblich reduziert.
- Machine à coudre à base plate, une aiguille, point noué, pour piquage des chaussures, avec entraînement par roué et par aiguille et avec pied à roulette entraîné, longueur maximale du point 7 mm. La machine est munie d'un crochet vertical XXL surdimensionné qui hausse de 70% la capacité en fil de bobine et réduit du coup le nombre de changements de bobines.

887-160142

- Same as 887-160040, but equipped with automatic thread trimmer, automatic back tack, and presser foot lift.
- Las mismas características que la 887-160040, pero con corta-hilos automático, remate automático y alza-prensatelas.
- Baugleich mit 887-160040 aber mit automatischem Fadenabschneider, automatischer Verriegelung und Nähfußlüftung ausgestattet.
- Identique au modèle 887-160040, mais avec coupe-fils automatique, d'un bridage automatique de la couture par arrêt et d'un releveur du pied presseur.

887-260020

- Double needle lockstitch flat bed machine with wheel feed, needle feed and driven roller presser and a maximum stitch length of 5 mm. Standard needle gauge 2 mm.
- Máquina de placa plana de doble pespunte, de dos agujas con transporte de rueda corrediza y de aguja, pata rodante accionada, longitud máxima de puntada 5 mm. Distancia entre agujas estándar 2 mm.
- Zweinadel-Doppelsteppstich-Flachbettmaschine mit Schiebrad und Nadeltransport und angetriebenem Rollfuß, maximale Stichtlänge 5 mm. Standard Nadelabstand ist 2 mm
- Machine à coudre à base plate, deux aiguilles, point noué, pour piquage des chaussures, avec entraînement par roué et par aiguille et avec pied à roulette entraîné, longueur maximale du point 5 mm. Écartement d'aiguilles standard de 2 mm.

887-260122

- Same as 887-260020, but equipped with automatic thread trimmer, automatic back tack, and presser foot lift.
- Las mismas características que la 887-260020, pero con corta-hilos automático, remate automático y alza-prensatelas.
- Baugleich mit 887-260020, aber mit automatischem Fadenabschneider, automatischer Verriegelung und Nähfußlüftung ausgestattet.
- Identique au modèle 887-260020, mais avec coupe-fils automatique, d'un bridage automatique de la couture par arrêt et d'un releveur du pied presseur.

TECHNICAL SPECIFICATIONS

MACHINE SPEED
max 3000 spm

OILING SYSTEM
fully automatic

STITCH LENGTH
single needle - max 7 mm
double needle - max 5 mm

FEED TYPE
reversible needle feed
top driven roller and wheel feed

PRESSER FOOT LIFT
max 12 mm

NEEDLE TYPE
134 LR

ROLLER PRESSER
standard 35 mm ø



ZZ 512

(fig 1)  ZZ 512 + ZZ 512 H

(fig 2)  ZZ 513 + ZZ 513 H

(fig 3)  ZZ 514 + ZZ 514 H

Global ZZ 510 Series ZIG-ZAG SEWING MACHINE

ZZ 512

- Single needle, drop feed, flatbed, zig-zag sewing machine with fully automatic lubrication and horizontal axis rotary hook for sewing light to medium material. Stitch type: two point zig-zag (fig. 1).
- Máquina de una aguja zig-zag, arrastre por dientes con lubricación automática y gancho sobre eje horizontal. Para materiales ligeras y media pesadas. Tipo de puntada: zig-zag de dos puntadas. (Fig. 1).
- Einnadel, Zick-Zack Maschine mit Untertransport, vollautomatische Schmierung und Horizontalgreifer, für leichtes bis mittleres Material. Stichbild: 2-Stich Zick-Zack (Fig.1).
- Machine zig-zag, 1 aiguille entraînement par griffe avec lubrification automatique et crochet sur axe horizontal pour la couture sur article léger à moyen. Type de point: zig-zag deux points (fig. 1).

ZZ 513

- Same as ZZ 512, but with three point zig-zag stitch type (fig. 2).
- Las mismas características que la ZZ 512, pero con zig-zag de tres puntadas (Fig. 2).
- Baugleich mit ZZ 512, jedoch mit 3-Stich Zick-Zack (Fig. 2).
- Identique à la ZZ 512, mais avec point zig-zag trois points (fig. 2).

ZZ 514

- Same as ZZ 512, but with four point zig-zag stitch type (fig. 3).
- Las mismas características que la ZZ 512, pero con zig-zag de cuatro puntadas (Fig. 3).
- Baugleich mit ZZ 512, jedoch mit 4-Stich Zick-Zack (Fig. 3).
- Identique à la ZZ 512, mais avec point zig-zag quatre points (fig. 3).

ZZ 512 H

- Single needle, upper- and lower feed, flatbed, zig-zag sewing machine with fully automatic lubrication and horizontal axis rotary hook for sewing medium material, such as leather, canvas, etc. Stitch type: two point zig-zag (fig. 2).
- Máquina de una aguja zig-zag, arrastre por dientes y pata con lubricación automática y gancho sobre eje horizontal. Para materiales media pesadas, como cuero, lona etc. Tipo de puntada: zig-zag de 2 puntadas. (Fig. 2).
- Einnadel, Zick-Zack Maschine mit Unter-, Nadel- und alternierendem Obertransport, vollautomatische Schmierung und Horizontalgreifer, für mittleres Material. Stichbild: 2-Stich Zick-Zack (Fig. 2).
- Machine zig-zag avec entraînement supérieur et inférieur, lubrification automatique et crochet sur axe horizontal pour couture sur article moyen, comme le cuir, ou la toile etc. Type de point: zig-zag deux points (fig. 2).

ZZ 513 H

- Same as ZZ 512 H, but with three point zig-zag stitch type (fig. 1).
- Las mismas características que la ZZ 512 H, pero con zig-zag de tres puntadas (Fig. 1).
- Baugleich mit ZZ 512 H, jedoch mit 3-Stich Zick-Zack (Fig. 1).
- Identique à la ZZ 512 H, mais avec point zig-zag trois points (fig. 1).

ZZ 514 H

- Same as ZZ 512 H, but with four point zig-zag stitch type (fig. 3). This machine is no stock item, but can be ordered upon request.
- Las mismas características que la ZZ 512 H, pero con zig-zag de 4 puntadas (Fig. 3). Esta máquina no es un artículo en stock, pero puede ser pedido a petición.
- Baugleich mit ZZ 512 H, jedoch mit 4-Stich Zick-Zack (Fig. 3). Nicht ab Lager lieferbar, nur auf Anfrage.
- Identique à la ZZ 512 H, mais avec point zig-zag quatre points (fig. 3). Machine non stockée, livrable sur commande.

TECHNICAL SPECIFICATIONS

MACHINE SPEED
max 2000 spm

OILING SYSTEM
fully automatic

STITCH LENGTH
max 5 mm

PRESSER FOOT LIFT
By hand max 7 mm
By knee max 10 mm

NEEDLE TYPE
Standard type: 134 R
H-type: 135x17

ZIG-ZAG WIDTH
max 8 mm

The ultimate
Zig-Zag



ZZ 217 SERIES

Global ZZ 217 Series SINGLE NEEDLE ZIG-ZAG SEWING MACHINES

ZZ 217

High quality single needle zig-zag sewing machine, with special horizontal axis rotary hook for sewing light to medium materials.

Máquina alta calidad de una aguja zig-zag con gancho sobre eje horizontal special, para materiales ligeras y media pesadas.

Höhe qualitäts Einnadel, Zick-Zack Maschine mit speziellen Horizontalgreifer zum Nähen von leichtes bis mittleres Materialien.

Machine Haute qualité zig-zag une aiguille avec un crochet special sur axe horizontal pour la couture sur article léger à moyen.

ZZ 217-3S

High quality single needle, cam controlled, zig-zag sewing machine with special horizontal axis rotary hook for sewing light to medium materials. Stitch type: four point zig-zag.

Máquina alta calidad de una aguja zig-zag, controlado por disco, con y gancho sobre eje horizontal special, para materiales ligeras y media pesadas. Tipo de puntada: zig-zag de 4 puntadas.

Höhe qualitäts Einnadel, Zick-Zack Maschine, durch Kurvenscheiben gesteuert, mit speziellen Horizontalgreifer zum Nähen von leichtes bis mittleres Materialien. Stichbild: 4-Stich Zick-Zack.

Machine Haute qualité zig-zag une aiguille, contrôlée par came, avec un crochet special sur axe horizontal pour la couture sur article léger à moyen. Type de point: zig-zag quatre points.

ZZ 217-3S-P

Same as ZZ 217-3S, but with puller.

Mismas características que la ZZ 217-3S, pero con puller.

Baugleich mit ZZ 217-3S, jedoch mit puller.

Identique à la ZZ 217-3S, mais avec puller.

TECHNICAL SPECIFICATIONS

MACHINE SPEED
max 2200 spm

OILING SYSTEM
manual

STITCH LENGTH
max 5,5 mm

PRESSER FOOT LIFT
max 8,5 mm

NEEDLE TYPE
134 ZZ / 265 / 438 / DP x 438

NEEDLE SIZE
Nm 70-120

WORKING SPACE
265 x 128 mm

ZIG-ZAG WIDTH
max 12 mm

PULLER
optional

STITCH TYPE:
4 step / 3 stitch



Global ZZ 2560 PROLINE Series HIGH SPEED ZIG-ZAG MACHINES

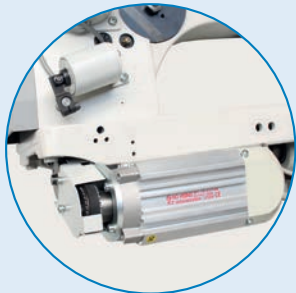

Built-on motor use only (all models)



Easily inter-changeable cams

ZZ 2567 Standard with 2 pattern cams!



Cam 038



Cam 058

Cam specification

2 Standard cams with each machine model					
Part no S080	Cam number	Pattern width mm		Stitch diagram	MAX. SEWING SPEED
		MIN	MAX		
...674113	038	4.5	10		3800
...674235	058	4	10		2000
Extra available cams					
...674114	039	4.5	10		3800
...674115	040	3.5	6		3800
...674116	041	4.5	10		3800
...674117	042	3.5	6		3800
...674118	043	4	6		3800
...674119	044	4	10		3800
...674120	045	2	5		3800
...674121	046	2	5		3800
...674122	047	3.5	6		3800
...674123	048	4.5	10		3800
...674125	050	2	6		3800
...674219	037	0	0	 for adjusting	4400
...674221	051	3.5	6		3800
...674226	052	2	4.5		3800
...674227	053	1	2.4		3800
...674228	054	1.5	4		3800
...674229	055	3.5	6		3800
...674124	049	4.5	10		4400

SPECIFICATIONS ZZ 2560 PROLINE SERIES

MODEL	MAX. STITCH WIDTH MM	PRESSER FOOT LIFT (MM)	NEEDLE SYSTEM	NEEDLE Nm	Nm Synthetic Cotton	MAX. SEWING SPEED	THREAD TRIMMING DEVICE
ZZ 2565 High speed 6 mm flatbed zig-zag sewing machine	6	12	134	80-110	20/3 30/3	5500	—
ZZ 2565 AUT Same as ZZ 2565 - but with thread trimmer, back tack and presser foot lifter (electric)	6	12	134	80-110	20/3 30/3	5000	•
ZZ 2567 High speed 10 mm flatbed zig-zag sewing machine for decorative stitching	10	12	134	80-110	20/3 30/3	Cam related	—
ZZ 2567 AUT Same as ZZ 2567 - but with underbed thread trimmer, back tack and presser foot lifter (electric)	10	12	134	80-110	20/3 30/3	Cam related	•
ZZ 2568 High speed 10 mm flatbed zig-zag sewing machine for medium heavy fabric used in the shoe industry	10	12	134-35	100-130	10/3 10/3	3400	—
ZZ 2568 AUT Same as ZZ 2568 - but with thread trimmer, back tack and presser foot lifter (electric). Used in the shoe industry	10	12	134-35	100-130	10/3 10/3	3400	•



ALL MODELS



Global ZZ 2560 PROLINE Series HIGH SPEED ZIG-ZAG MACHINES

ZZ 2565/2568

- High speed zig-zag machine, semi automatic lubrication, built-in bobbinwinder. Sliding excentric reverse feed, pendant link feed mechanism.
- Máquinas de zig zag de alta velocidad, lubricación semi automática, devanador de canilla acoplado. Deslizamiento excéntrico del inversor de puntada y mecanismo de transmisión del arrastre suspendido.
- Hochleistungs Zick-Zack Schnellnäher mit halbautomatischer Schmierung und eingebautem Spulapparat. Umschaltung auf Rückwärtsstich durch Gelenk und Gleitexcenter.
- Machine zig-zag à grande vitesse, lubrification semi automatique, bobinoir incorporé. Marche arrière par excentrique, mécanisme de griffe par bielles suspendues.

ZZ 2565/2568 AUT

- Same as ZZ 2565/2568, but equipped with automatic thread trimmer, back tack and presser foot lifter. (all electric)
- La misma que ZZ 2565/2568, pero equipada con corta-hilos automático, alza-prensateles y remate automático. (eléctrico)
- Baugleich mit ZZ 2565/2568, jedoch ausgestattet mit automatischem Fadenabschneider, Fußlüftung und Verriegelung. (elektrisch)
- Identique à la ZZ 2565/2568, mais équipée avec coupe-fil, relevage de pied et arrêts automatiques (électromagnétique)

ZZ 2567

- High speed, cam controlled, fancy stitch zig-zag machine, standard supplied with 2 cams. Extra: 18 optional cams.
- Máquinas de zig zag variable en puntadas de fantasía, de alta velocidad y controladas por levas intercambiables. Con la máquina se sirven 2 discos estándar con diferente patrón y existen otros 18 discos disponibles.
- Hochleistungs Zick-Zack Ziernahtmaschine durch Kurvenscheiben gesteuert. Standard mit 2 verschiedene Zierstich-Muster-Kurvenscheiben. 18 zusätzliche Muster-Kurvenscheiben sind lieferbar.
- Machine zig-zag à grande vitesse, point décoratif contrôlé par came, livré avec 2 cames de motifs différents. 18 cames librables en option.

ZZ 2567 AUT

- Same as ZZ 2567, but equipped with automatic thread trimmer, back tack and presser foot lifter. (all electric)
- La misma que ZZ 2567, pero equipada con corta-hilos automático, alza-prensateles y remate automático. (eléctrico)
- Baugleich mit ZZ 2567, jedoch ausgestattet mit automatischem Fadenabschneider, Fußlüftung und Verriegelung. (elektrisch)
- Identique à la ZZ 2567, mais équipée avec coupe-fil, relevage de pied et arrêts automatiques. (électromagnétique)

TECHNICAL SPECIFICATIONS

MACHINE SPEED

ZZ 2565: max 5000 spm
ZZ 2567: depends on the cam
ZZ 2568: max 3400 spm

OILING SYSTEM

semi automatic

HOOK TYPE

ZZ 2565: standard hook
ZZ 2567/2568: large hook

STITCH LENGTH

max 5 mm

PRESSER FOOT LIFT

max 12 mm

NEEDLE TYPE

ZZ 2565/2567: 134
ZZ 2568: 134-35

ZIG-ZAG WIDTH

ZZ 2565 : max 6 mm
ZZ 2567/2568: max 10 mm

OPTIONAL ZZ 2560 SERIES:

- electric presser foot lift (standard on AUT version)
- electric back tack (standard on AUT version)

Global ZZ 1567 Series ZIG-ZAG FANCY STITCH MACHINES

The Global ZZ 1567 is a single needle high speed flatbed zig-zag machine with a variety of cams. This industrial machine is designed for decorative zig-zag stitching. The ZZ 1567 AUT is equipped with thread trimmer, back tack and presser foot lifter (electric).

Cam specification



4-Row feed dog for positive fabric control



Easily inter-changeable cams

2 Standard cams with each machine model

Part no S080	Cam number	Pattern width mm		Stitch diagram	MAX. SEWING SPEED
		MIN	MAX		
...674113	038	4.5	10		3800
...674235	058	4	10		2000

Extra available cams

...674114	039	4.5	10		3800
...674115	040	3.5	6		3800
...674116	041	4.5	10		3800
...674117	042	3.5	6		3800
...674118	043	4	6		3800
...674119	044	4	10		3800
...674120	045	2	5		3800
...674121	046	2	5		3800
...674122	047	3.5	6		3800
...674123	048	4.5	10		3800
...674125	050	2	6		3800
...674219	037	0	0	 for adjusting	4400
...674221	051	3.5	6		3800
...674226	052	2	4.5		3800
...674227	053	1	2.4		3800
...674228	054	1.5	4		3800
...674229	055	3.5	6		3800
...674124	049	4.5	10		4400

SPECIFICATIONS ZZ 1567 SERIES

MODEL	MAX. STITCH WIDTH MM	PRESSER FOOT LIFT (MM)	SPACE TO RIGHT OF NEEDLE	NEEDLE SYSTEM	NEEDLE Nm	Nm Synthetic Cotton	MAX. SEWING SPEED	THREAD TRIMMING DEVICE
ZZ 1567 High speed 10 mm flatbed zig-zag sewing machine for decorative stitching	10	12	265	134 R	80-130	20/3 30/3	Cam related	—
ZZ 1567 AUT Same as ZZ 1567 - with underbed thread trimmer, back tack and presser foot lifter (electric)	10	12	265	134 R	80-130	20/3 30/3	Cam related	•



Global ZZ 1567 Series ZIG-ZAG FANCY STITCH MACHINES

ZZ 1567

- High speed, cam controlled, fancy stitch zig-zag machine, standard supplied with 2 cams.
Extra: 18 optional cams.
- Máquinas de zig zag variable en puntadas de fantasía, de alta velocidad y controladas por levas intercambiables. Con la máquina se sirven 2 discos estándar con diferente patrón y existen otros 18 discos disponibles.
- Hochleistungs Zick-Zack Ziernahtmaschine durch Kurvenscheiben gesteuert. Standard mit 2 verschiedene Zierstich-Muster-Kurvenscheiben. 18 zusätzliche Muster-Kurvenscheiben sind lieferbar.
- Machine zig-zag à grande vitesse, point décoratif contrôlé par came, livré avec 2 cames de motifs différents. 18 cames librables en option.

ZZ 1567 AUT

- Same as ZZ 1567, but equipped with automatic thread trimmer, back tack and presser foot lifter. (all electric)
- La misma que ZZ 1567, pero equipada con corta-hilos automático, alza-prensatejas y remate automático. (eléctrico)
- Baugleich mit ZZ 1567, jedoch ausgestattet mit automatischem Fadenabschneider, Fußlüftung und Verriegelung. (elektrisch)
- Identique à la ZZ 1567, mais équipée avec coupe-fil, relevage de pied et arrêts automatiques (électromagnétique)

Standard with 2 pattern cams!



Cam 038



Cam 058

TECHNICAL SPECIFICATIONS

MACHINE SPEED
max 4000 spm
(depends on the cam)

OILING SYSTEM
semi automatic

HOOK TYPE
large hook

STITCH LENGTH
max 5 mm

PRESSER FOOT LIFT
max 12 mm

NEEDLE TYPE
134

ZIG-ZAG WIDTH
max 10 mm

OPTIONAL EXTRA'S ZZ 1567:

- Electric presser foot lift
(standard on AUT version)
- Electric back tack
(standard on AUT version)

Global ZZ 1560 Series HIGH SPEED ZIG-ZAG MACHINES

The ZZ 1560 series are semi-lubricated, fast running, zig-zag machines.

ZZ 1560 series are usable on a wide variety of materials. These machines are also available with an electric underbed thread trimmer, back tack and presser foot lifter (electric).

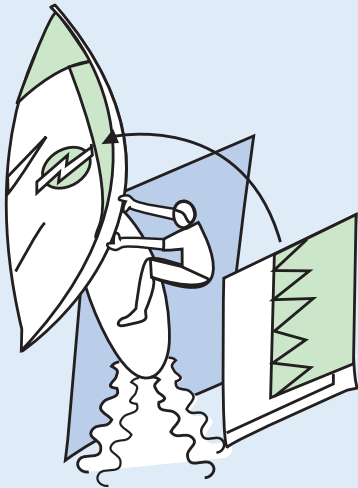

Global ZZ 1566

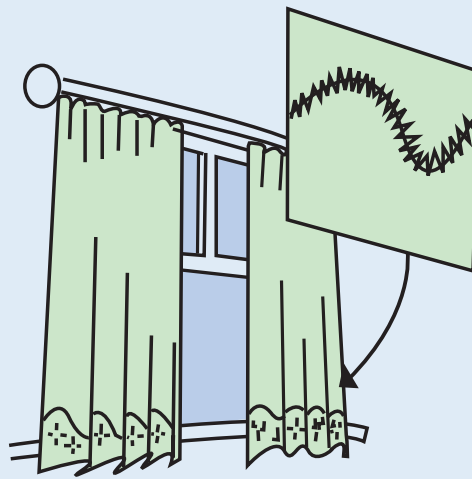

Global ZZ 1565

SPECIFICATIONS ZZ 1560 SERIES

MODEL	MAX. STITCH WIDTH MM	PRESSER FOOT LIFT (MM)	NEEDLE SYSTEM	NEEDLE Nm	Nm		MAX. SEWING SPEED	THREAD TRIMMING DEVICE
					Synthetic	Cotton		
ZZ 1565 High speed 6 mm flatbed zig zag sewing machine	6	12	134	80-110	20/3	30/3	5500	—
ZZ 1565 AUT Same as ZZ 1565 - but with thread trimmer, back tack and presser foot lifter (electric)	6	12	134	80-110	20/3	30/3	5000	•
ZZ 1566 High speed 10 mm flatbed zig-zag sewing machine	10	12	134	80-110	20/3	30/3	4400	—
ZZ 1566 AUT Same as ZZ 1566 - but with thread trimmer, back tack and presser foot lifter (electric)	10	12	134	80-110	20/3	30/3	4400	•
ZZ 1568 High speed 10 mm flatbed zig-zag sewing machine for medium heavy fabric used in the shoe industry	10	12	134-35	100-130	10/3	10/3	3400	—
ZZ 1568 AUT Same as ZZ 1568 - but with thread trimmer, back tack and presser foot lifter (electric) Used in the shoe industry	10	12	134-35	100-130	10/3	10/3	3400	•



Global ZZ 1560 Series

HIGH SPEED ZIG-ZAG MACHINES

ZZ 1560

High speed zig-zag machines, semi automatic lubrication, built-in bobbinwinder.
Sliding excentric reverse feed, pendant link feed mechanism.

Máquinas de zig zag de alta velocidad, lubricación semi automática, devanador de canilla acoplado. Deslizamiento excéntrico del inversor de puntada y mecanismo de transmisión del arrastre suspendido.

Hochleistungs Zick-Zack Schnellnäher mit halbautomatischer Schmierung und eingebautem Spulapparat. Umschaltung auf Rückwärtsstich durch Gelenk und Gleitexcenter.

Machine zig-zag à grande vitesse, lubrification semi automatique, bobinoir incorporé.
Marche arrière par excentrique, mécanisme de griffe par bielles suspendues.

ZZ 1560 AUT

Same as ZZ 1560, but equipped with automatic thread trimmer, back tack and presser foot lifter. (all electric)

La misma que ZZ 1560, pero equipada con corta-hilos automático, alza-prensateclas y remate automático. (eléctrico)

Baugleich mit ZZ 1560, jedoch ausgestattet mit automatischem Fadenabschneider, Fußlüftung und Verriegelung. (elektrisch)

Identique à la ZZ 1560, mais équipée avec coupe-fil, relevage de pied et arrêts automatiques (électromagnétique)

TECHNICAL SPECIFICATIONS

MACHINE SPEED

ZZ 1565 max 5000 spm
ZZ 1566 max 4400 spm
ZZ 1568 max 3400 spm

OLING SYSTEM

semi automatic

FEED TYPE

drop feed

HOOK TYPE

1565 standard hook
1566 / 1568 large hook

PRESSER FOOT LIFT

max 12 mm

STITCH LENGTH

max 5 mm

NEEDLE TYPE

1565/1566 = 134
1568 = 134-35

ZIG-ZAG WIDTH

ZZ 1565 max 6 mm
ZZ1566/ZZ1568 max 10 mm

OPTIONAL EXTRA'S ZZ 1560:

- presser foot lift
- back tack
(all pneumatic or electric)



185 mm



FOZ 523 H

(fig 1)  FOZ 522 + FOZ 522 H

(fig 2)  FOZ 523 + FOZ 523 H

(fig 3)  FOZ 524 + FOZ 524 H

Global FOZ 520 Series FEED OFF THE ARM ZIG-ZAG MACHINES

FOZ 522

- Single needle, drop feed, feed off the arm zig-zag sewing machine with horizontal axis rotary hook for sewing light to medium material. Stitch type: two point zig-zag (fig.1).
- Máquina zig-zag de 1 aguja y arrastre sencillo con brazo de alimentación con garfio sobre eje horizontal para coser generos fino y medio fino. Tipo de puntada: zig-zag de dos puntadas.
- 1 Nadel, Freiarm Zickzackmaschine mit Untertransport, Horizontalgreifer, für leichtes bis mittleres Material.
- Machine bras déporté zig-zag 1 aiguille, entraînement par griffe avec crochet sur axe horizontal. Pour couture sur articles légers à moyens. Type de point : zig-zag deux points (fig.1)

FOZ 523

- Same as FOZ 522, but with three point zig-zag stitch type (fig. 2).
- Las mismas características que la anterior, pero con zig-zag de tres puntadas.
- 1 Nadel, Freiarm, Dreistich Zickzackmaschine mit Untertransport, Horizontalgreifer, für leichtes bis mittleres Material.
- Identique à la FOZ 522 , mais avec type de zig-zag trois points (fig.2)

FOZ 524

- Same as FOZ 522, but with four point zig-zag stitch type (fig. 3)
- Las mismas características que la anterior, pero con zig-zag de cuatro puntadas.
- 1 Nadel, Freiarm, Vierstich Zickzackmaschine mit Untertransport, Horizontalgreifer, für leichtes bis mittleres Material.
- Identique à la FOZ 522 , mais avec type de zig-zag quatre points (fig.3)

FOZ 522 H

- Single needle, walking foot, feed off the arm zig-zag sewing machine with horizontal axis rotary hook for sewing light to medium material, such as leather, canvas etc. Stitch type: two point zig-zag (fig 1.)
- Máquina zig-zag de 1 aguja y arrastre por dientes y pata con brazo de alimentación con garfio sobre eje horizontal para coser materiales medio pesados y pesados, como cuero, lona etc. Tipo de puntada: zig-zag de dos puntadas.
- 1 Nadel, Freiarm Zickzackmaschine mit Obertransport, Horizontalgreifer, für leichtes bis mittleres Material.
- Machine bras déporté zig-zag 1 aiguille, entraînement combiné, avec crochet sur axe horizontal. Pour couture sur articles moyens à lourds comme toile de tente, cuir, etc. Type de point: zig-zag deux points (fig.1)

FOZ 523 H

- Same as FOZ 522 H, but with three point zig-zag stitch type (fig. 2).
- Las mismas características que la anterior, pero con zig-zag de tres puntadas.
- 1 Nadel, Freiarm Dreistich Zickzackmaschine mit Obertransport, Horizontalgreifer, für leichtes bis Mittleres Material.
- Identique à la FOZ 522 H , mais avec type de zig-zag trois points (fig.2)

FOZ 524 H

- Same as FOZ 522 H, but with four point zig-zag stitch type (fig. 3)
- Las mismas características que la anterior, pero con zig-zag de cuatro puntadas.
- 1 Nadel, Freiarm Vierstich Zickzackmaschine mit Obertransport, Horizontalgreifer, für leichtes bis mittleres Material.
- Identique à la FOZ 522 H, mais avec type de zig-zag quatre points (fig.3)

TECHNICAL SPECIFICATIONS

MACHINE SPEED
max 1800 spm

OILING SYSTEM
fully automatic

STITCH LENGTH
max 5 mm

PRESSER FOOT LIFT
By hand max 7 mm
By knee max 10 mm

NEEDLE TYPE
Standard type: 134 R
H type: 135x17

ZIG-ZAG WIDTH
max 7 mm

CYLINDER CIRCUMFERENCE
185 mm

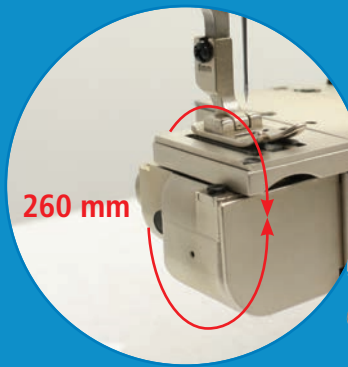

260 mm



- (fig 1)  CBZ 532 + CBZ 532 H
- (fig 2)  CBZ 533 + CBZ 533 H
- (fig 3)  CBZ 534 + CBZ 534 H

CBZ 532 H

Global CBZ 530 Series

SINGLE NEEDLE, DROP FEED, CYLINDERBED ZIG ZAG MACHINES

CBZ 532

- Single needle, drop feed, cylinderbed, zig-zag sewing machine with fully automatic lubrication and horizontal axis rotary hook for sewing light to medium material. Stitch type: two point zig-zag (fig. 1).
- Máquina de una aguja zig-zag de brazo, arrastre por dientes con lubricación automática y gancho sobre eje horizontal. Para materiales ligeras y media pesadas. Tipo de puntada: zig-zag de 2 puntadas. (Fig. 1)
- Einnadel, Freiarm Zick-Zack Maschine mit Untertransport, vollautomatische Schmierung und Horizontalgreifer, für leichtes bis mittleres Material. Stichbild: 2-Stich Zick-Zack (Fig. 1).
- Machine canon zig-zag 1 aiguilles, entraînement par griffe avec lubrification automatique et crochet sur axe horizontal, pour la couture sur article léger à moyen. Type de point: zig-zag deux points (fig. 1).

CBZ 533

- Same as CBZ 532, but with three point zig-zag stitch type (fig. 2). This machine is no stock item, but can be ordered upon request.
- Las mismas características que la CBZ 532, pero con zig-zag de 3 puntadas. (Fig. 2). Esta máquina no es un artículo en stock, pero puede ser pedido a petición.
- Baugleich mit CBZ 532, jedoch mit 3-Stich Zick-Zack (Fig. 2). Nicht ab Lager lieferbar, nur auf Anfrage.
- Identique à la CBZ 532 mais avec point zig-zag trois points (fig. 2). Machine non stockée, livrable sur commande.

CBZ 534

- Same as CBZ 532, but with four point zig-zag stitch type (fig. 3). This machine is no stock item, but can be ordered upon request.
- Las mismas características que la CBZ 532, pero con zig-zag de 4 puntadas. (Fig. 3). Esta máquina no es un artículo en stock, pero puede ser pedido a petición.
- Baugleich mit CBZ 532, jedoch mit 4-Stich Zick-Zack (Fig. 3). Nicht ab Lager lieferbar, nur auf Anfrage.
- Identique à la CBZ 532 mais avec point zig-zag quatre points (fig. 3). Machine non stockée, livrable sur commande.

CBZ 532 H

- Single needle, upper- and lower feed, cylinderbed, zig-zag sewing machine with fully automatic lubrication and horizontal axis rotary hook for sewing medium material, such as leather, canvas, etc. Stitch type: two point zig-zag (fig. 1).
- Máquina de una aguja zig-zag de brazo, arrastre por dientes y pata, con lubricación automática y gancho sobre eje horizontal. Para materiales media pesadas. Tipo de puntada: zig-zag de 2 puntadas. (Fig. 1)
- Einnadel, Freiarm Zick-Zack Maschine mit Unter-, Nadel- und alternierendem Obertransport, vollautomatische Schmierung und Horizontalgreifer, für mittleres Material. Stichbild: 2-Stich Zick-Zack (Fig. 1).
- Machine canon zig-zag 1 aiguille, entraînement supérieur et inférieur, avec lubrification automatique et crochet sur axe horizontal, pour la couture sur article moyen, comme le cuir, ou la toile etc. Type de point: zig-zag deux points (fig.1).

CBZ 533 H

- Same as CBZ 532 H, but with three point zig-zag stitch type (fig. 2). This machine is no stock item, but can be ordered upon request.
- Las mismas características que la CBZ 532 H, pero con zig-zag de 3 puntadas. (Fig. 2). Esta máquina no es un artículo en stock, pero puede ser pedido a petición.
- Baugleich mit CBZ 532 H, jedoch mit 3-Stich Zick-Zack (Fig. 2). Nicht ab Lager lieferbar, nur auf Anfrage.
- Identique à la CBZ 532 H, mais avec point zig-zag trois points (fig. 2). Machine non stockée, livrable sur commande.

CBZ 534 H

- Same as CBZ 532 H, but with four point zig-zag stitch type (fig. 3). This machine is no stock item, but can be ordered upon request.
- Las mismas características que la CBZ 532 H, pero con zig-zag de 4 puntadas. (Fig. 3). Esta máquina no es un artículo en stock, pero puede ser pedido a petición.
- Baugleich mit CBZ 532 H, jedoch mit 4-Stich Zick-Zack (Fig. 3). Nicht ab Lager lieferbar, nur auf Anfrage.
- Identique à la CBZ 532 H, mais avec point zig-zag quatre points (fig. 3). Machine non stockée, livrable sur commande.

TECHNICAL SPECIFICATIONS

MACHINE SPEED
max 1600 spm

OILING SYSTEM
fully automatic

STITCH LENGTH
max 5 mm

PRESSER FOOT LIFT
By hand max 7 mm
By knee max 10 mm

NEEDLE TYPE
Standard type: 134 R
H-type: 135x17

ZIG-ZAG WIDTH
max 8 mm

CYLINDER CIRCUMFERENCE
260 mm



(fig 1)  LPZ 9912 + LPZ 9912 H

(fig 2)  LPZ 9913 + LPZ 9913 H

(fig 3)  LPZ 9914 + LPZ 9914 H



LPZ 9912

Global LPZ 9910 Series

SINGLE NEEDLE, DROP FEED, POSTBED, ZIG-ZAG MACHINES

LPZ 9912

- Single needle, drop feed, postbed, zig-zag sewing machine with fully automatic lubrication and horizontal axis rotary hook for sewing light to medium materials. Stich type: two point zig-zag (fig. 1).
- Máquina de una aguja zig-zag de poste, arrastre por dientes, con lubricación automática y gancho sobre eje horizontal. Para materiales ligeras y media pesadas. Tipo de puntada: zig-zag de 2 puntadas. (Fig. 1).
- Einnadel, Zick-Zack Säulenmaschine mit Untertransport, vollautomatische Schmierung und Horizontalgreifer, für leichtes bis mittleres Material. Stichbild: 2-Stich Zick-Zack (Fig. 1).
- Machine zig-zag pilier 1 aiguille, entraînement par griffe, avec lubrification automatique et crochet sur axe horizontal pour couture sur article léger à moyen. Type de point: zig-zag deux points (fig.1).

LPZ 9913

- Same as LPZ 9912, but with three point zig-zag stitch type (fig. 2). This machine is no stock item, but can be ordered upon request.
- Las mismas características que la LPZ 9912, pero con zig-zag de 3 puntadas. (Fig. 2). Esta máquina no es un artículo en stock, pero puede ser pedido a petición.
- Baugleich mit LPZ 9912, jedoch mit 3-Stich Zick-Zack (Fig. 2). Nicht ab Lager lieferbar, nur auf Anfrage.
- Identique à la LPZ 9912, mais avec zig-zag trois points type (fig. 2). Machine non stockée, livrable sur commande.

LPZ 9914

- Same as LPZ 9912, but with four point zig-zag stitch type (fig. 3). This machine is no stock item, but can be ordered upon request.
- Las mismas características que la LPZ 9912, pero con zig-zag de 4 puntadas. (Fig. 3). Esta máquina no es un artículo en stock, pero puede ser pedido a petición.
- Baugleich mit LPZ 9912, jedoch mit 4-Stich Zick-Zack (Fig. 3). Nicht ab Lager lieferbar, nur auf Anfrage.
- Identique à la LPZ 9912, mais avec zig-zag quatre points type (fig. 3). Machine non stockée, livrable sur commande.

LPZ 9912 H

- Single needle, upper- and lower feed, postbed, zig-zag sewing machine with fully automatic lubrication and horizontal axis rotary hook for sewing medium material, such as leather, canvas, etc. Stich type: two point zig-zag (fig. 1). This machine is no stock item, but can be ordered upon request.
- Máquina de una aguja zig-zag de poste, arrastre por dientes y pata, con lubricación automática y gancho sobre eje horizontal. Para materiales media pesadas. Tipo de puntada: zig-zag de 2 puntadas. (Fig. 1). Esta máquina no es un artículo en stock, pero puede ser pedido a petición.
- Einnadel, Zick-Zack Säulenmaschine mit Unter-, Nadel- und alternierendem Obertransport, Vollautomatische Schmierung und Horizontalgreifer, für mittleres Material. Stichbild: 2-Stich Zick-Zack (Fig. 1). Nicht ab Lager lieferbar, nur auf Anfrage.
- Machine pilier zig-zag 1 aiguille, entraînement supérieur et inférieur, avec lubrification automatique et crochet sur axe horizontal, pour la couture sur article moyen, comme le cuir, ou la toile etc. Type de point: zig-zag deux points (fig.1). Machine non stockée, livrable sur commande.

LPZ 9913 H

- Same as LPZ 9912 H, but with three point zig-zag stitch type (fig. 2). This machine is no stock item, but can be ordered upon request.
- Las mismas características que la LPZ 9912 H, pero con zig-zag de 3 puntadas. (Fig. 2). Esta máquina no es un artículo en stock, pero puede ser pedido a petición.
- Baugleich mit LPZ 9912 H, jedoch mit 3-Stich Zick-Zack (Fig. 2). Nicht ab Lager lieferbar, nur auf Anfrage.
- Identique à la LPZ 9912 H mais avec point zig-zag trois points (fig. 2). Machine non stockée, livrable sur commande.

LPZ 9914 H

- Same as LPZ 9912 H, but with four point zig-zag stitch type (fig. 3). This machine is no stock item, but can be ordered upon request.
- Las mismas características que la LPZ 9912 H, pero con zig-zag de 4 puntadas. (Fig. 3). Esta máquina no es un artículo en stock, pero puede ser pedido a petición.
- Baugleich mit LPZ 9912 H, jedoch mit 4-Stich Zick-Zack (Fig. 3). Nicht ab Lager lieferbar, nur auf Anfrage.
- Identique à la LPZ 9912 H mais avec point zig-zag quatre points (fig. 3). Machine non stockée, livrable sur commande.

TECHNICAL SPECIFICATIONS

MACHINE SPEED
max 1200 spm

OILING SYSTEM
fully automatic

MAX. STITCH LENGTH
max 5 mm

PRESSER FOOT LIFT
By hand max 7 mm
By knee max 10 mm

NEEDLE TYPE
Standard type: 134 R
H-type: 135x17

ZIG-ZAG WIDTH
max 8 mm



GLOBAL GL 3811 GATHERING MACHINE FOR SHOE UPPER

Single needle, gathering lockstitch machine, with large hook for shoe upper. The differential feed and variable top feed ensure accurate gathering. Mechanical gathering control: by operating the switch, at the needle bar end of the machine, which changes from flat sewing to gathering.

The machine will be supplied with Ho Hsing i-drive motor, automatic presser foot lifter, edge guide, tape guide and tape reel bracket. The machine is suitable for processing California style shoes, clogs and moccasins. To increase the gathering effect, a reinforcing tape is sewn on simultaneously and holds the gathering in place.

Máquina pespunte de embeber previo, de una aguja, gancho grande para el parte superior del zapato. El avance diferencial y el arrastre superior variable aseguran trabajo de embebido exacto. El control manual de embeber : manejando el nudillo al final de la barra de aguja con dos ajustes de embebido. La máquina es suministrada con motor Ho Hsing i-drive, alza-prensatejas, guía, guía de cinta y soporte para el rollo de cinta. La máquina es adecuado para el proceso del zapato estilo Californiano, zuecos y mocasines. Una cinta de refuerzo es cosido al mismo tiempo para incrementar el efecto de embebido y mantener el embebido en su sitio.

1 Nadel Doppelsteppstichmaschine mit großem Greifer zum Vorkräuseln von Lederteilen mit Bändchen. Der mechanische Differential- Obertransport sorgt für ein gleichmäßiges Einkräuseln. Die Zuschaltung erfolgt über einen Knopf am Nähkopf. Durch die Bandführung wird die Kräuselwirkung verstärkt und die Form besser fixiert. Die Maschine ist ausgestattet mit einem Ho Hsing i drive Motor, automatischer Presserfußblüftung, Kantenführer, Bandhalter mit Bandbremse am Kopf und Bändchenführung im Nähfuß. Einsatzgebiete sind unter anderem die Schuhfertigung (Kalifornien Schuhe, Clogs und Mokassins), Polstermöbelindustrie , allgemeines Vorkräuseln von Lederteile.

Machine une aiguille pour fronce en point noué , avec crochet grande capacité pour plateau de chaussures. L'entraînement différentiel supérieur réglable permet de réaliser des fronces de qualité. Contrôle de la valeur de fronce par contact près de la barre aiguille permettant d'alterner entre deux valeurs. La machine est livrée avec un moteur Ho Hsing « i-drive », relevage automatique du pied, guide bord, guide bande et support de bande de renfort. La machine est utilisée pour le montage California, les mocassins et sabots. Pour augmenter l'effet de fronce, une bande de renfort est cousue simultanément et maintient les fronces en place.

Máquina de uma agulha para franzir, com lançadeira grande. Equipada com diferencial de transporte para garantir um franzido ótimo. Sistema de franzir mecânico atuado através de joelheira. A máquina vem equipada com motor Ho Hsing I-drive , levantamento de calçador automático, guia lateral, guia para fita e suporte para o rolo de fita.

A máquina é adequada para fazer sapatos estilo Califórnia, mocassins. Para aumentar o efeito de franzido e o manter no mesmo sítio a máquina cose uma fita de reforço ao mesmo tempo.

TECHNICAL SPECIFICATIONS

MACHINE SPEED
max 2000 spm

OILING SYSTEM
Manual
hook automatic

GATHERING STITCH LENGTH
2 mm (lockstitch)

STANDARD STITCH LENGTH
max 8 mm

PRESSER FOOT LIFT
max 5 mm

NEEDLE TYPE
DP x 17



OS 7200

INDUSTRIAL SEWING MACHINES

Global OS 7200 ORNAMENTAL STITCHING MACHINE

Ornamental stitch, cylinderbed machine with 2 needles, which can carry out functional and ornamental stitching on uppers, suitcases, bags etc. Supplied with interchangeable cams to sew 12 different patterns. Complete with table top, stand and Ho Hsing servomotor.

Máquina cilíndrica de brazo de puntada decorativa de 2 agujas se pueda usar para trabajos funcionales y decorativos de zapatos, carteras, bolsos etc. La máquina tiene 12 diferentes patrones por medio de discos intercambiables. Completa con tablero, bancada y motor Ho Hsing.

Zylinderarm Zierstichmaschine mit 2 Nadeln, geeignet für Zierstiche auf Obermaterialien, Koffern und Taschen u.s.w. Wird mit 12 Mustern geliefert durch austauschbare Kurvenscheibe. Die Maschine wird komplett mit Nähtisch und Ho Hsing Servomotor geliefert.

Une machine canon 2 aiguilles pour la réalisation de points utilitaires ou d'ornements de la chaussure, bagagerie, maroquinerie etc. 12 dessins standard. La machine est livrée complète avec bâti et moteur Ho Hsing.

Uma máquina braço cilíndrico, de duas agulhas, que executa costuras funcionais e ornamentais em gáspeas e malas, bolsos e tecidos pesados como jeans, guarda-sol, toldos e sofás. O modelo OS 7200 dispõe de 12 programas. A máquina será entregue com os pés, tampo e servomotor Ho Hsing.

Single needle stitches

Double needle stitches

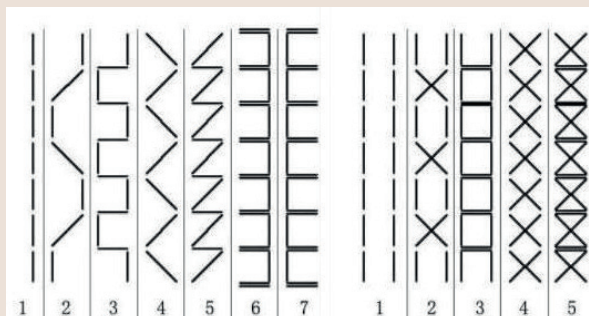

TECHNICAL SPECIFICATIONS

MACHINE SPEED
max 250 spm

OILING SYSTEM
manual

STITCH LENGTH
max 10 mm

PRESSER FOOT LIFT
max 10 mm

NEEDLE TYPE
DD x 1

NEEDLE GAUGES
4,5 - 5,5 - 7,5
all necessary parts in the accessory box.



OS 7706

INDUSTRIAL SEWING MACHINES

Global OS 7706 ORNAMENTAL STITCHING MACHINE FOR THE SHOE INDUSTRY

OS 7706

- Double needle, flatbed ornamental stitching machine with double roller presserfoot, which can carry out functional and ornamental stitching on shoe-wear, suitcases and bags. This machine has 200 different patterns (100 patterns single needle and 100 patterns double needle), controlled by stepping motors. This machine is delivered complete with table top, special stand and mini motor.
- Máquina base plana, 2 agujas y doble ruleta para cosidos decorativos para puntadas decorativas en zapato, maletas y bolsas. La máquina tiene 200 patrones diferentes (100 patrones para 1 aguja y 100 patrones para 2 agujas), controlado por motor paso a paso. La máquina se entrega complete con tablero, estante especial y mini motor.
- Máquina de costura plana ornamental de duas agulhas de roletos com levantamento que executa costuras funcionais e ornamentais em gáspeas, bolsas e malas. Esta máquina dispõe de 200 programas diferentes, (100 programas com uma agulhas e 100 programas com duas agulhas) controlada por motores. Esta máquina é entregue completa com tampo especial e motor.

TECHNICAL SPECIFICATIONS

MACHINE SPEED
max 550 spm

STITCH LENGTH
max 12 mm

PRESSER FOOT LIFT
max 15 mm

PRESSER FOOT LIFT
Pneumatic

NEEDLE TYPE
DY x 3

**NEEDLE BAR ROTATING
SYSTEM**
By stepping motors

NUMBER OF PATTERNS
100 single needle
100 double needle

STANDARD NEEDLE GAUGE
6,5 mm

OPTIONAL NEEDLE GAUGES
8 mm/ 10 mm



WF 35



WF 1335 LH

Global WF 1335 Series CYLINDER ARM, WALKING FOOT MACHINES

WF 1335

- Single needle, cylinder arm, needle feed, walking foot machine with regular hook.
- Máquina de una aguja, brazo cilíndrico con arrastre por dientes, aguja y pata. Garfio normal.
- Einnadel-, Zylinderarm-, Steppstichmaschine mit Unter-, Nadel- und alternierendem Obertransport. Die Maschine hat einen normalen Horizontalgreifer.
- Machine canon, 1 aiguille, triple entraînement avec crochet standard.

WF 1335 B

- Same as WF 1335, but equipped for binding work (binder not included).
- Las mismas características que la WF 1335, pero equipada para ribetear (embudo no incluido).
- Baugleich mit WF 1335, jedoch mit mitgehender Einfaß-Vorrichtung (ohne Einfasser). Besonders geeignet zum Einfassen von engen Rundungen.
- Identique au modèle WF 1335, avec en plus équipement pour le bordage (guide bordeur non compris).

WF 1335 LH

- Same as WF 1335, but equipped with large capacity hook.
- Las mismas características que la WF 1335, pero equipada con garfio grande.
- Baugleich mit WF 1335, jedoch mit großem Greifer.
- Identique au modèle WF 1335, mais avec crochet à grande capacité.

WF 1335 B-LH

- Same as WF 1335 B, but equipped with large capacity hook.
- Las mismas características que la WF 1335 B, pero equipada con garfio grande.
- Baugleich mit WF 1335 B, jedoch mit großem Greifer.
- Identique au modèle WF 1335 B, mais avec crochet à grande capacité.

WF 1335 LH-AUT

- Same as WF 1335 LH, but electric thread trimmer, pneumatic presser foot lifter and back tack.
- Las mismas características que la WF 1335 LH, pero equipada con corta-hilos eléctrico y remate neumático. Viene con alza-prensatelas neumáticas.
- Baugleich mit WF 1335 LH, jedoch mit elektrischer Fadenabschneider, automatischer Verriegelung Und Presserfußlüftung ausgestattet.
- Identique au modèle WF 1335 LH, mais équipée avec dispositif coupe fil, commande pneumatique du dispositif d'arrêts et du relevage du pied automatique.

TECHNICAL SPECIFICATIONS

MACHINE SPEED
max 2400 spm

OILING SYSTEM
manual

FEED TYPE
drop feed, needle feed
walking foot

STITCH LENGTH
max 6 mm

PRESSER FOOT LIFT
by hand max 5 mm
by pedal max 14 mm

PRESSER FOOT LIFTER
optional (pneumatic)

NEEDLE TYPE
134x35



INSIDE OPANKA

Global SM 7500 SHOE PRODUCTION MACHINE

Single needle lockstitch sewing machine for side stitching of shoe soles. The machine is equipped with a small horn. This horn is used for side stitching of the shoes and box soles, also for stitch surmounting the tip of the upper. Specially designed for boots and children's shoes. Complete with table top, special stand and Ho Hsing servomotor.

Máquina de pespunte para coser los lados del suelo de zapato. La máquina esta equipada con un brazo chico. El brazo para coser los lados y suelos de caja del zapato, también para coser alrededor de la punta de la parte arriba del zapato. Especialmente para zapato de niño y botas. Completa con tablero, bancada y motor servo Ho Hsing.

Máquina de coser dos lados da sola do sapato. A máquina está equipada com um braço pequeno. O braço para coser os lados e caixa de solas do sapato, também para coser à volta da ponta da parte de cima do sapato. Especialmente para sapato de criança e botas. A máquina será entregue com os pés, tampo e servomotor Ho Hsing.

TECHNICAL SPECIFICATIONS

MACHINE SPEED
max 600 SPM

STITCH LENGTH
3 - 10 mm

PRESSER FOOT LIFT
standard (electric)

SEWING THICKNESS
2 - 6 mm

NEEDLE TYPE
4035



SM 7555

Global SM 7555 Series SHOE PRODUCTION MACHINES

SM 7555

Single needle lockstitch machine for sewing box soles onto shoes and ankle boots. This machine is equipped with floating horn support to make sewing easy around the toe and heel. Max. daily production 1000 pairs. Complete with table top, special stand and Ho Hsing servo motor.

Máquina de pespunte de una aguja para coser el suelo de caja al zapato y botas cortas. La máquina esta equipada con un brazo flotante para facilitar coser alrededor de la punta y la parte trasera del zapato. Producción máxima de 1.000 pares al día. Completa con tablero, bancada y motor servo Ho Hsing.

Máquina de coser de una agulha para coser solas de caixa do sapato e botas curtas. A máquina está equipada com um braço flutuante para facilitar o coser a volta da ponta e da parte traseira do sapato. Produção máxima de 1.000 pares por dia. A máquina será entregue com os pés, tampo e servomotor Ho Hsing.

SM 7555 LA

Same as above, but with extra long arm, suitable for boots etc.

Las mismas características que la anterior, pero con brazo extra largo, para coser botas.

As mesmas características que a anterior, mas com um braço extra largo, para coser botas.

SM 7555 NA

Same as above, but with "small" horn for fine work like children's shoes.

Las mismas características que la anterior, pero con brazo "chico" para trabajos finos como en zapato de niño.

As mesmas características que a anterior, mas com um braço pequeno para trabalhos finos como o sapato de criança.

TECHNICAL SPECIFICATIONS

MACHINE SPEED
max 900 SPM

STITCH LENGTH
3 - 13 mm

PRESSER FOOT LIFT
standard (electric)

SEWING THICKNESS
7555 : 1,5 - 6 mm
7555 LA : 2,0 - 8 mm
7555 NA : 1,5 - 6 mm

ARM LENGTH
7555 : 230 mm
7555 LA : 360 mm
7555 NA : 230 mm

HOOK SIZE
7555 : ø 50 mm
7555 LA : ø 50 mm
7555 NA : ø 42,5 mm

NEEDLE TYPE
CPx5



SINGLE NEEDLE



DOUBLE NEEDLE



SM 7555 OS



PATTERN CAM

Global SM 7555 OS ORNAMENTAL STITCHING MACHINE

SM 7555 OS

– Double needle lockstitch ornamental sewing machine equipped with floating horn which supports easy sewing around the toe and heel. This special box sole sewing machine can sew 12 different patterns, which can be set by interchangeable cams. The machine is delivered complete with table top, special stand and Ho Hsing i-90/ 750 watt motor.

– Máquina de 2 agujas con brazo flotante de puntada decorativa que facilita coser alrededor de los dedos de pie y tacón. La máquina de coser suela especial puede coser 12 tipos de puntadas diferentes, ajustado cambiando los discos. La máquina se entrega completa con tablero especial y Ho Hsing i-90/ 750 watt motor.

– Máquina de costura ornamental de duas agulhas equipada com braço flutuante para facilitar o coser à volta da biqueira e da parte traseira do sapato. Esta máquina de costura com uma caixa especial pode costurar 12 padrões diferentes, que podem ser ajustados por cams. Esta máquina é entregue completa com tampo especial, bancada e Ho Hsing i-90/ 750 watt motor.

TECHNICAL SPECIFICATIONS

MACHINE SPEED
max 600 SPM

STITCH LENGTH
4 - 12 mm

PRESSER FOOT LIFT
standard (electric)

SEWING THICKNESS
1,5 - 6 mm

ARM LENGTH
310 mm

STANDARD NEEDLE GAUGE
6 mm

NUMBER OF PATTERNS
12

NEEDLE TYPE
CPx5

SEWING PATTERN	1 or 2 NEEDLES	SEWING PATTERN	1 or 2 NEEDLES
	1 NEEDLE		1 NEEDLE
	2 NEEDLES		2 NEEDLES
	1 NEEDLE		1 NEEDLE
	2 NEEDLES		1 NEEDLE
	1 NEEDLE		1 NEEDLE
	2 NEEDLES		2 NEEDLE



Global SM 7555 SL SPECIAL SHOE PRODUCTION MACHINE FOR SANDALS

“Special” single needle lockstitch machine for sewing soles onto sandal and slipper style footwear. This machine is equipped with floating horn support to make sewing around the toe, heel and inside strap easy. Max. daily production 1000 pairs. This machine is delivered with table top, stand and Ho Hsing servomotor.

Máquina especial de pespunte, 1-aguja para coser la suela a tipo sandalias y chanclas. La máquina esta equipada con brazo flotante para coser fácil alrededor de los dedos de pie, tacón y la correa interior. Producción máxima al día 1.000 pares. Se entrega con tablero, estante y servo motor Ho Hsing.

“Especial” Máquina de costura de uma agulha para coser solas em sandálias e chinelos estilo calçado. Esta máquina é equipada com braço flutuante para fazer a costura à volta da biqueira e na parte de traseira. Produção diária de 1000 pares. Esta máquina é entregue completa com tampo especial, bancada e servomotor Ho Hsing.

TECHNICAL SPECIFICATIONS

MACHINE SPEED
max 900 SPM

STITCH LENGTH
3 - 13 mm

PRESSER FOOT LIFT
standard (electric)

SEWING THICKNESS
MAX. 6 MM

NEEDLE TYPE
CPx5



Global SM 7568 XH SHOE PRODUCTION MACHINE

Single needle extra heavy duty lockstitch machine for sewing box soles onto workshoes and ankle boots. This machine is equipped with floating horn support to make sewing around the toe and heel easy. Max. daily production 1000 pairs. Complete with table top, special stand and Ho Hsing servo motor.

Máquina de pespunte de una aguja para trabajos extra pesados cosiendo suelos de caja al zapato y botas cortas. La máquina esta equipada con un brazo flotante para facilitar coser alrededor de la punta y parte trasero del zapato. Producción maximo de 1.000 pares al día. Completa con tablero, bancada y motor servo Ho Hsing.

Máquina de coser de uma agulha para trabalhos extra pesados cosendo caixas de solas do sapato e botas curtas. A máquina está equipada com um braço flutuante para facilitar o coser à volta da ponta e parte traseira do sapato. Produção máxima de 1.000 pares por dia. A máquina será entregue com os pés, tampo e servomotor Ho Hsing.

TECHNICAL SPECIFICATIONS

MACHINE SPEED
max 900 SPM

STITCH LENGTH
3 - 12 mm

PRESSER FOOT LIFT
standard (electric)

SEWING THICKNESS
1,5 - 8 mm

NEEDLE TYPE
CPx5



OUTSIDE OPANKA



Global SM 7570 CH SERIES SHOE PRODUCTION MACHINES

SM 7570 CH

Single needle lockstitch, seated type, inseam sewing machine. The machine is equipped with a special horn designed for outside OPANKA stitching on children shoes. Complete with table top, special stand and Ho Hsing servo motor.

Máquina de casco de 2-hilos. La máquina esta equipada con un cuerno especial para coser la suela de caja a zapatos pequeños de niño incluso subiendo encima de la nariz del zapato. La máquina se suministra con tablero, bancada y motor servo Ho Hsing.

Máquina de coser solas de 2-fios. A máquina esta equipada com bigorna especial para coser a sola de caixa para sapatos pequenos de criança, assim como para coser em o sapato de caixa com sola em cima. A máquina esta equipada com, bancada e servomotor Ho Hsing.

SM 7570 CH-NA

Same as SM 7570 CH, but equipped with extra small horn for small children shoes.

Las mismas características que la SM 7570 CH , pero con brazo extra pequeño para zapatos de niños pequeños.

As mesmas características que a SM 7570 CH, mas com um braço pequeno para sapatos de crianças pequenas.

TECHNICAL SPECIFICATIONS

MACHINE SPEED
max 450 spm

STITCH LENGTH
3,6 - 10 mm

PRESSER FOOT LIFT
standard (electric)

SEWING THICKNESS
1,5 - 6 mm

NEEDLE TYPE
CP X 5



SM 7748

Global SM 7748 SHOE PRODUCTION MACHINE

Curved needle sewing machine for stitching upper directly on the bottom.
This machine is specially made for sandals and slippers. This machine is able to carry out 2 kinds of stitches as drawing: "stitch out" (kit A) and "bordo" (kit B). You can realize one of these stitches according to fixing the sewing guide unit "A" or "B" (Both supplied with the machine). Complete with table top, special stand and Ho Hsing servo motor.

Máquina con la aguja curvada para coser la parte superior a la parte inferior.
La máquina es apropiada para sandalias y zapatillas. Puede llevar a cabo 2 tipos de puntadas como se aprecia en la figura abajo: "stitch out" (conjunto A) y "bordo" (conjunto B). Se puede realizar uno de estos puntadas aplicando el conjunto A o B (Los 2 conjuntos se suministra con la máquina).
Completa con tablero, bancada y motor servo Ho Hsing.

Máquina para produção para calçado Máquina com a agulha curvada para coser a parte superior e a parte inferior. Máquina especial para coser sandalias sapatilhas. Pode levar a cabo 2 tipos de trabalho como se pode vêr na figura em baixo; "stitch out" (conjunto A) y "bordo" (conjunto B). Pode-se aplicar um destes trabalhos aplicando o conjunto A ou B. (os dois conjuntos são incorporados na máquina) Completa com tampo, bancada e servomotor Ho Hsing.

TECHNICAL SPECIFICATIONS

MACHINE SPEED
max 450 spm

STITCH LENGTH
6 - 10 mm

PRESSER FOOT LIFT
standard (pneumatic)

SEWING THICKNESS
2 - 6 mm

NEEDLE TYPE
special curved needle
DY x 100

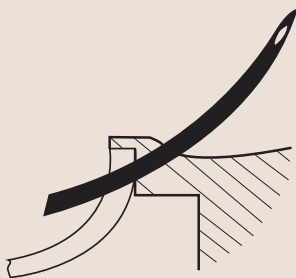

Kit A

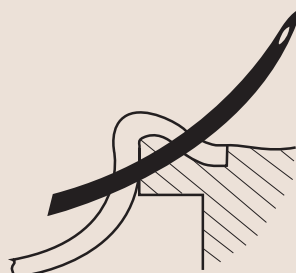

Kit B

INDUSTRIAL SEWING MACHINES



Global SM 7746 SOLE STITCHING MACHINE

Single needle, sole stitching machine. This machine is a special shoe machine with a curved needle, made to sew an upper to a sole in "stitch and turn" style. After the sewing operation the shoe is turned inside out and the stitch is virtually invisible. Stitch length 6 – 10 mm. This machine is delivered standard with table top, special stand and Ho Hsing servomotor.

Máquina de coser suela de 1 aguja. La máquina especial con aguja curvada para coser el parte superior del zapato a la suela en estilo al revés. Después de la operación el zapato se gira de dentro hacia fuera y la puntada es invisible, ya que esta a dentro. Larga de puntada de 6 - 10 mm. Esta máquina se entrega con tablero, estante especial y motor servo Ho Hsing.

Máquina de uma agulha de costura única. Esta máquina é uma máquina para sapatos especiais (sabras) com agulha curva, feita para costurar a parte superior a uma sola com estilo "reverso". Após a costura o sapato é virado de dentro para fora e o ponto é praticamente invisível. Com um comprimento de ponto de 6 a 10mm. Esta máquina é entregue completa com tampo especial, bancada e servomotor Ho Hsing.

TECHNICAL SPECIFICATIONS

MACHINE SPEED
max 600 spm

STITCH LENGTH
6-10 mm

SEWING THICKNESS
Max. 3 mm

PRESSER FOOT LIFT
Standard (pneumatic)

NEEDLE TYPE
Special curved needle
DY x 100



Global SM 7900 ES SHOE PRODUCTION MACHINE

Espadrille outside seam sewing machine with curved needle, suitable for stitching hemp soles on flat espadrille style shoes. Stitch length 4-10mm. The machine is delivered with table top, special stand and Ho Hsing servomotor. Max. machine speed 600 spm.

Máquina de coser la costura afuera de la alpargatas con una aguja curvada, apropiada para coser suelas de esparto, de estilo alpargatas planas. Larga de puntada de 4 - 10 mm. Se entrega con tablero, estante especial y motor servo Ho Hsing. Velocidad máxima 600 p.p.m.

Máquina de costura para coser alpargatas com agulha curvada, adequada para coser solas de rafia em sapatos estilo alpargatas. Com um comprimento de ponto de 4 a 10mm. Esta máquina é entregue completa com tampo especial, bancada e servomotor Ho Hsing, com uma velocidade máxima de 600 rpms.

TECHNICAL SPECIFICATIONS

MACHINE SPEED
max 600 SPM

STITCH LENGTH
4 – 10 mm

PRESSER FOOT LIFT
standard (electric)

NEEDLE TYPE
PGX100



MILANO

Global SM 7747 SHOE PRODUCTION MACHINE

Single needle moccasin sewing machine with curved needle to reproduce the special shoemaker stitch. Different kits available for special finish. S, B and C kit come standard with the machine. Machine is delivered with table top, special stand and Ho Hsing servo motor.

Máquina de pespunte de una aguja para coser mocasines con aguja curvada para reproducir una puntada zapatero autentica. Se puede suministrar con varios equipos para terminaciones especiales. La maquina esta equipada con tablero, bancada y servomotor Ho Hsing. Kit S, B y C vienen standar con la máquina.

Máquina de coser com uma agulha para coser mocassins com agulha curvada para reproduzir o idêntico coser manual. Diferentes kits possíveis para terminações especiais. A máquina será entregue com os pés, tampo e servomotor Ho Hsing. Kit S, B e C ja vem incorporados na maquina.

Standard: Kit S

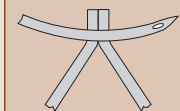

Standard: Kit B

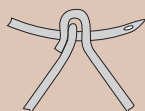

Standard: Kit C



Optional: Kit D

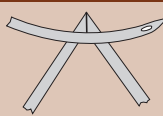

Optional: Kit E

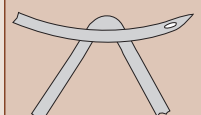

Optional: Kit F

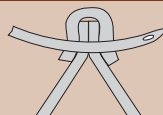

TECHNICAL SPECIFICATIONS

MACHINE SPEED
max 450 spm

STITCH LENGTH
6 - 10 mm

PRESSER FOOT LIFT
standard (pneumatic)

SEWING THICKNESS
2 - 6 mm

NUMBER OF NEEDLES
1

NEEDLE TYPE
special curved needle
DY x 100

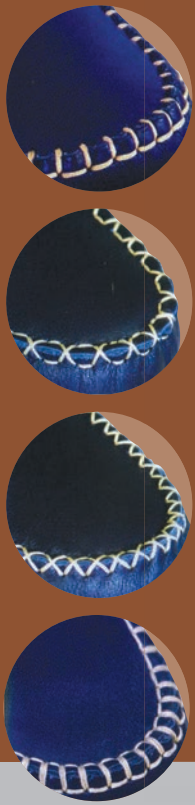

Box stitch device

SM 7777

Global SM 7777 SHOE PRODUCTION MACHINE

Double needle feed off the arm sewing machine, specially designed for tubular closed and open moccasins. 12 different patterns can be set by interchangeable cams. The transport of the material is carried out by a left and right feed dog, which can be adjusted separately. According to the different settings of the feed dogs, ruffling effect can be realized. The amount of ruffling can be changed manually by knee control during working sewing operation. This machine is equipped with start/end thread locking box stitch device in combination with cross stitch.

Complete with table top special stand and Ho Hsing servo motor.

Máquina de coser de brazo de alimentación, doble aguja, diseñada especialmente para coser mocasines abiertos y cerrados. 12 patrones diferentes mediante levas intercambiables. El material es transportado por dientes de alimentación izquierda y derecha, y pueden ser ajustados por separado. Según la posición de los dientes, se pueden realizar diferentes efectos de fruncido. La cantidad de fruncido se puede ajustar manualmente a través de la rodillera durante el cosido. Esta máquina está equipada con el dispositivo de puntada de cuadro ó 'x' al inicio y final. Completa con tablero, bancada y motor servo Ho Hsing.

Máquina de costura de braço, 2 agulhas, especialmente projetada para moccasins tubulares abertos e fechados. 12 desenhos diferentes podem ser definidos por cames substituíveis. O transporte do material é realizado pelo arraste direito e esquerdo, os quais podem ser ajustados eparadamente. De acordo com as definições de arraste, efeitos podem ser realizados. A quantidades de efeitos podem ser modificadas manualmente pela joelheira durante a operação de costura. Esta maquina esta equipada com começo e final em quadrado em combinação com o ponto utilizado.

Completa com tampo, bancada e motor servo Ho Hsing.

TECHNICAL SPECIFICATIONS

MACHINE SPEED
max 400 SPM

STITCH LENGTH
max 10 mm

PRESSER FOOT LIFT
standard (electric)

SEWING THICKNESS
max 4 mm

NEEDLE GAUGE
6 mm

NUMBER OF PATTERNS
12

NEEDLE TYPE
DDx1

INDUSTRIAL SEWING MACHINES



SM 7774



SM 7773

Global SM 7770 Series SHOE PRODUCTION MACHINES

SM 7773

Three needle chainstitch, low postbed sewing machine ideal for stitching work shoes, safety shoes, hunting shoes and boots, sandals and slippers. Machines are also suitable to sew luggage, bags, sporting goods (body protectors, punching bags, etc.) and a diversity of other items. Speeds of over 1600 stitches per minute are possible, depending upon the application. Complete with table top, special stand and Ho Hsing servo motor.

Maquina de poste bajo, cadeneta de 3 hilos, excelente para coser zapato de trabajo, calzado de seguridad, botas o sandalias y changlas de baile. También para aplicar bolsos de equipaje, ropa de deporte etc. (protectores de cuerpo o sacos de boxeo) y mucho articulos diversos. Es posible de trabajar con velocidades por encima de 1.600 puntadas por minuto, pendiente de la aplicación. Completa con tablero, bancada y motor Ho Hsing.

Maquina de coluna baixa, cadeneta de 3 fios, excelente para coser sapato de trabalho, calçado de segurança botas ou sandalias y zapatos de baile. Tambem para aplicar bolsos de equipaje, roupa de desporto etc. (protectores de corpo ou sacos de boxe) e muitos artigos diversos. É possível trabalhar com velocidades para cima de 1.600 spm, dependente das aplicações. Completa com tampo, bancada y servomotor Ho Hsing.

SM 7774

Same as above, however a four needle chainstitch machine with a standard needle gauge of 7,2 mm

Las mismas características que la anterior, pero maquina de poste bajo, cadeneta de 4 hilos. Distancia entre las agujas 7,2 mm.

As mesmas características que a anterior, mas maquina de coluna baixa, cadeneta de 4 fios. Distancia de agulhas 7,2 mm.

TECHNICAL SPECIFICATIONS

MACHINE SPEED
max 1600 spm

STITCH TYPE
single thread chain stitch

STITCH LENGTH
3 - 6 mm

PRESSER FOOT LIFT
standard (pneumatic)

SEWING THICKNESS
2 - 6 mm

NUMBER OF NEEDLES
3 or 4

AVAILABLE NEEDLE GAUGES
SM 7773 = 6,4 or 4,8 mm
SM 7774 = 7,2 mm



Global SM 7840 RL RIB LAYING MACHINE FOR GOODYEAR WELT

This machine attaches the rib to the sole by the use of heat and pressure. The rib circulates in a hot drum which preheats it while at the same time, by the use of a current of hot air, activates the rib and the glued area to achieve greater adhesion of the rib. An automatic cutting device cuts the rib in an exact, predetermined place, facilitating the following operations in the production process. Furthermore, thanks to its adjustable guide we can vary the distance of the rib from the edge of the sole, which is without doubt the best cement for conducting the following processes in the Goodyear production. The design of this machine enables the rib to be applied in either round and thin-toed shoes or cowboy boots. The variostop electronic motor ensures that the machine will always stop with the hammer in the up position so as to remove the shoe and insert the next sole.

Esta máquina coloca o lábio na palmilha através de calor e pressão. O lábio circula num tambor quente que ao mesmo tempo a pré-aquece, usando uma corrente de ar quente que ativa o lábio e a área colada para alcançar uma maior adesão. Um dispositivo de corte automático corta o lábio facilitando o processo de fabrico. Além disso, graças à sua guia ajustável, que pode variar a distância do lábio a partir da borda da palmilha. A construção desta máquina, permite aplicar o lábio em vários tipos de modelos de palmilhas (sapatos redondos, sapatos senhora).

A mesma vem equipada com motor eletrónico para permitir uma paragem eficaz e permitir que o martelo pare sempre na posição aberta, para facilmente remover a palmilha e inserir outra.

La máquina ata el cerquillo al plantilla usando calor y presión. El cerquillo circula dentro bidón, cual calienta el material y al mismo tiempo, con el uso de un corriente de aire caliente activa la área de la cola para adquirir mas adhesión del cerquillo. Un dispositivo de corte automático corta el cerquillo exacto en el sitio predeterminado, facilitando la siguiente operación en el proceso de producción. Además, gracias a las guías ajustables, podemos variar la distancia del cerquillo al orilla de la plantilla, cual es sin duda el mejor cemento para llevar a cabo los siguientes procesos en la producción de "Goodyear". El diseño de esta máquina permite de aplicar tanto calzado de punta redondo como en punta fino o botas vaquero. El motor electrónico vario-stop asegura que la máquina para con el martillo en posición arriba para quitar e insertar la plantilla siguiente.

TECHNICAL SPECIFICATIONS

MACHINE SPEED

Stepless speed regulation

POWER USE PRE-HEATER

400 watt - 220 volts

POWER USE HEATER

500 watt – 220 volts

DAILY PRODUCTION

Approx: 100 pair / hour



Global SM 7860 ST STAPLING MACHINE FOR GOODYEAR WELT

This machine is used in Goodyear production, to tighten the cut to the last and fit it to the rib by using staples, which the machine itself produces from a roll of wire. The adjustable pincers, facilitate the tightening operation, pulling the leather and the lining against the rib while the machine nails the staples. As the wire is very thin, it does not complicate to make the welt stitching. This machine has been designed to solve the common problems of mechanical machines, by replacing the brake and clutch with a variable speed electronic motor.

Esta máquina é usada na produção de Goodyear para apertar o corte ao lábio da palmilha, usando agrafos que a própria máquina produz a partir do rolo de arame. As pinças ajustáveis facilitam a operação do aperto, puxando a pele e o forro contra o lábio enquanto a máquina coloca o agrafos. O arame é muito fino para facilitar a costura da vira. Esta máquina foi concebida para resolver os problemas comuns das máquinas mecânicas, para isso foi substituído o travão e a embraiagem mecânica por um motor eletrónico.

Esta máquina se emplea en la producción "Goodyear" para juntar el corte al forro y fijarlo al enfranke usando grapas, que la máquina misma produzca de un rolo de cable de acero. Las pinzas ajustables facilitan la operación de fijar, empujando cuero exterior y el forro contra el enfranke, mientras la máquina fija las grapas. Ya que el cable de acero es muy fino no complica hacer cosiendo la costura. La máquina esta diseñado para resolver los problemas común de las maquinas mecánicas, reemplazar el freno y el embrague por un motor electrónico de velocidad variable.

TECHNICAL SPECIFICATIONS

MACHINE SPEED
max 250 spm

STAPLE SHANK LENGTH
9 mm

STEEL WIRE DIAMETER
0,6 mm

MATERIAL THICKNESS
3-13 mm



Global SM 7810 GW GOODYEAR WELT INSEAM STITCHING MACHINE

This Goodyear welt, inseam chainstitch sewing machine, sews the welt on the rib of footwear manufactured in the Goodyear system. It perforates the shoe with an awl and a needle and it is sewn absolutely firmly thanks to the adjustable tension of the thread. This machine may optionally be adapted with different guides in order to work with various types of welts.

La máquina de coser la cerquilla a la bota tipo "Goodyear welt" pone el cerco a la bota con puntada cadeneta para calzado con el sistema "Goodyear". La máquina perfora la bota con un punzón y una aguja y queda muy firme gracias a la tensiones del hilo ajustables. La máquina se puede adaptar opcionalmente con diferentes guías para poder trabajar en varios tipos de "welt".

Esta máquina executa a costura através de ponto de cadeia, da vira com a borda do sapato no sistema Goodyear. Perfura o sapato com um furador, e uma agulha, fazendo uma costura extremamente firme devido ao regulador de tensão de linha. A mesma pode ser opcionalmente adaptada com guías diferentes, a fim de trabalhar com vários tipos de vira.

TECHNICAL SPECIFICATIONS

MACHINE SPEED

Stepless speed regulation

STITCH LENGTH

4-12 mm

SEWING THICKNESS

3-8 mm

NEEDLE TYPE

Groz-Beckert:
HN80/47.255.69 G



Global SM 7830 AL OUTSOLE STITCHING MACHINE

High speed outsole stitching machine with automatic lubrication system. This machine is suitable to sew, upside seams for the shoe upper and the shoe sole, especially those for the thick sole and the working boots. Thanks to its Ho Hsing, HVP90-750 watt servo motor, we can adjust the speed to the skills of the operator and the type of footwear. Max. daily production 600-1000 pairs. The machine is equipped with a wax thread box suitable for waterproof shoe stitching.

Máquina de coser suela exterior de alta velocidad con sistema lubricación automática. Máquina adecuada para coser la parte arriba del calzado a la suela, especialmente suela gruesa de botas de trabajo. Gracias a su motor Ho Hsing, HVP90-750 watt, puede variar la velocidad a la habilidad del operador ó el tipo de trabajo para coser. La producción diaria máximo es de 600 a 1.000 pares. La máquina viene equipada con una caja para cera, idóneo para coser botas a prueba de agua.

Máquina de coser solas sistema de lubrificação automático. É adequada para coser solas do sapato de sola grossa e as botas de trabalho. Graças ao seu motor Ho Hsing, HVP90-750 watt, é possível ajustar a velocidade à habilidade do operador e do tipo de calçado. Max. produção diária de 600-1000 pares. A máquina é equipada com uma caixa de fio de cera adequada para costura de sapatos à prova d'água. Máquina ideal para coser sistema "Pratik".

TECHNICAL SPECIFICATIONS

MACHINESPEED
max 600 spm

OILING SYSTEM
automatic

STITCH LENGTH
max 9 mm

PRESSER FOOT LIFT
max 20 mm

SEWING THICKNESS
max 18 mm

NEEDLE SYSTEM
Rapid curved: 6001 No. 43
Rapid awl : 8001 No. 37



Global SM 7820 MC SHOE PRODUCTION MACHINE

Single needle lockstitch horn shoe sewing machine of the McKay type. The leather soles are stitched to each upper by using the Blake/McKay method for supreme comfort and flexibility. The upper is wrapped around the insole and attached between it and the outsole. A single stitch attaches everything together. The stitches are concealed by a channel in the outsole and pass through the outsole, upper, lining, and insole. Because it is a simpler construction than a Goodyear welt, it is also less expensive. This machine can also be used for resoling once the outsole is worn or damaged.

Máquina de cuerno, 1-aguja de pespunte de calzado de tipo McKay. La suela de cuero esta cosido al parte superior usando el método Blake/McKay para una comodidad y flexibilidad supremo. La plantilla interior es envuelto por la parte superior y unido entre la plantilla y la suela exterior. Un solo pespunte une todas partes juntos. Los pespuntos se asientan en un canal de la suela exterior y pasan por a través de la suela exterior , parte superior del zapato, el forro y la plantilla interior. Por ser un construcción más simple que el "goodyear welt", también es menos costoso. También la máquina sirve para reponer una suela exterior cuando esté gastado o dañado.

Máquina de 1 agulha com braço para coser sapatos tipo Blake. As solas de couro são cosidas ao corte usando o sistema Blake/Mckay para um conforto superior e flexibilidade. O corte é virado por baixo da palmilha, ficando entre a palmilha e a sola, sendo unido pelo ponto. Os pontos são cosidos num refendado na sola, passando pelo corte, palmilha e sola unindo tudo. Como é uma construção mais simples que o sistema Goodyear, também fica mais barato. Está máquina também pode ser usada para coser solas novas quando a sola original estiver danificada.

TECHNICAL SPECIFICATIONS

MACHINE SPEED
Stepless speed regulation

STITCH LENGTH
max 18 mm

SEWING THICKNESS
max 20 mm

NEEDLE TYPE
Groz-Beckert:
HN83/53.240.62 G2

AVAILABLE HORNS
6 different horns available:
C,D,H,J,C2,D2

C2 and D2 same as C and D, but with smaller throatplate, to sew closer to the edge of shoe.

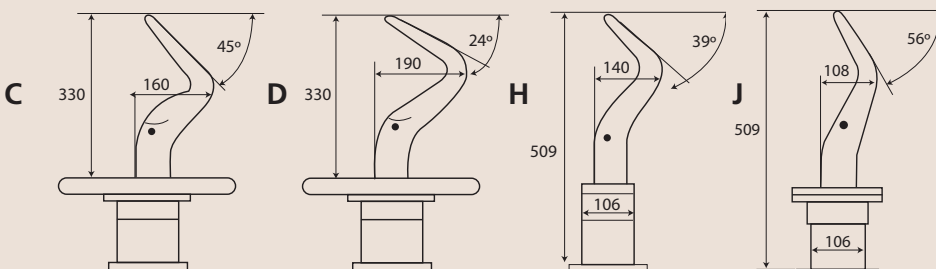



SM 9204-102

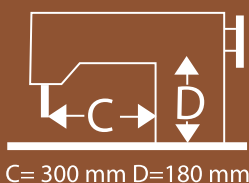

SM 9204-102 HEAVY DUTY CORDING SEWING MACHINE

Double needle, extra heavy duty flatbed sewing machine with large Barrel shuttle hook and roller presser. Specially designed for manufacturing various widths and sizes cord as required by the footwear trade, for fashionable finishes to footwear and by the leatherware trade, for adding attractive finishes to bags and cases of all kinds.

Máquina de dos agujas, de bordo extra pesado, base plana con gancho Grande de tipo 'barrel' y ruletas. Especialmente diseñado para manufacturar bordos de varios anchos y tipos de cordones para la industria de calzado, para acabados de moda en calzado y otros productos de cuero, haciendo acabados atractivos en bolsos y todo tipos de maletas.

Extrem schwere Zweinadel Flachbettnähmaschine mit grossem Barrelgreifer und 2 Rollfüssen. Die Maschine wurde entwickelt um verschiedene Grössen und Breiten von Kedern zu verarbeiten. In der Schuhproduktion wird dies für modische Endbearbeitungen an Schuhwerk benutzt, in der Lederindustrie für attraktive Endbearbeitungen an Taschen und Koffern aller Art.

Machine deux aiguilles, plate très lourde avec grande navette barrel, et pied à roulette. Spécialement réalisée pour la fabrication de cordages de différentes largeurs et dimensions pour la fabrication de chaussures, articles de finitions modes pour chaussures ou vêtements de cuir, ou pour articles de finition pour sac ou autres articles.

Máquina de base plana, 2 agulhas, para coser linhas grossas com Ançadeira de sino grande e calçador de rolete. Especialmente Construida para coser vários tipos e espessuras de linhas requeridas pela industria de calçado, para acabamentos no calçado para adicionar acabamentos atrativos em sacos e malas de todos os tipos.

TECHNICAL SPECIFICATIONS

MACHINE SPEED
max 650 spm

OILING SYSTEM
Manual

HOOK TYPE
shuttle hook

STITCH LENGTH
max 8 mm

PRESSER FOOT LIFT
by hand max 10 mm
by pedal max 15 mm

BACK TACK & PRESSER FOOT LIFT
optional (pneumatic)

NEEDLE TYPE
DYx3

NEEDLE DISTANCE
Standard: 5,5 mm
max needle distance: 8,0 mm

CORD SIZE
max 2 mm

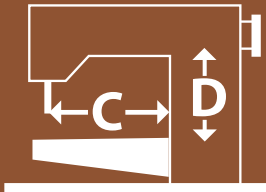

C=300 mm
D=200 mm



SM 9205

Global SM 9205 SHOE PRODUCTION MACHINE

Single needle, heavy duty, top feed, cylinderbed sewing machine with large shuttle hook to stitch narrow borders on soles. The narrow sewing parts are particular for stitching small borders (soles for shoes, sandals and slippers). Pneumatic presser foot lift is available as an option.

Máquina de 1-aguja, brazo cilíndrico de triple arrastre por pata para trabajo muy pesado con gancho de lanzadera para coser costuras estrechas en suelas. El equipo de costura estrecha son diseñados para coser grecas angostas (suelas de zapato, sandalias y chanclas). Alza-prensateclas son opcional.

Maquina de braço de 1 agulha para materiais pesados com lançadeira grande de sino, para coser a palmilha ao corte como por ex. PRATIK. inclui calcadores especiais para coser PRATIK, como solas de couro sandálias e chinelos. Levantamento pneumático encontra se disponível como opcional.

TECHNICAL SPECIFICATIONS

MACHINE SPEED
max 750 spm

OILING SYSTEM
manual

HOOK TYPE
Large shuttle hook

STITCH LENGTH
max 12 mm

PRESSER FOOT LIFT
by hand max 15 mm
by pedal max 20 mm

PRESSER FOOT LIFT
optional (pneumatic)

NEEDLE TYPE
DYx3

INDUSTRIAL SEWING MACHINES



Global BT 100 x 100 ELECTRONIC PATTERN SEWING MACHINE

GLOBAL BT 100 X 100

This programmable pattern sewing machine is suitable to sew medium / heavy materials with a sewing area of 100 x 100 mm. The height of presser foot lifter can be adjusted by a stepping motor. Patterns are programmable on the user friendly touch panel. The left and right clamp can be programmed to move down independently. The machine is delivered complete with table top, stand and a direct drive mini servo motor. Maximum machine speed 2400 spm. Optional available: roll-over clamp (not assembled).

Máquina de coser programable adecuada para coser materiales media-pesadas y pesadas con un área de 100 x 100 mm. La altura de la prensatelas programable con el motor paso a paso. Los dibujos son programable a través del panel táctil de uso fácil. La mordaza izquierda y derecha se puede bajar independientes. La máquina viene completa con tablero, estante y mini motor servo de acción directa. Máxima velocidad 2.400 p.p.m. Opcional pinza de vuelco.

Nähautomat für mittlere bis schwere Materialien mit einem Nähfeld von 100 x 100mm. Der Fusshub ist schrittmotorg esteuert. Nähprogramme werden einfach auf dem Bedienerfreundlichen Touch Panel programmiert. Die rechte und linke Klammer können jeweils separat programmiert werden. Die Maschine wird komplett geliefert mit Tischplatte, Gestell und Direct Drive Mini- Servomotor. Maximale Geschwindigkeit: 2400 SPM. Optional erhältlich: Etikettenklemme(nicht montiert).

Automate de couture pour article moyen/lourd avec une surface de travail de 100 x 100 mm. La hauteur du pied presseur est réglable par moteur pas à pas. Les dessins sont programmables à l'aide de la tablette tactile conviviale. Demi pince gauche et droite pouvant être programmés pour descendre indépendamment. Machine livrée complète avec table, bâti et mini servo moteur. Vitesse maximum de 2400 pts/mn. En option pince avec fixation rotative (non monté).

TECHNICAL SPECIFICATIONS

MACHINE SPEED
Max 2400 spm

FEEDING SYSTEM
By pulse motor (X- Y)

HOOK TYPE
large rotating hook

STITCH LENGTH
max 10 mm

PRESSER FOOT LIFT
max 16 mm

CLAMP LIFT
Up to 20 mm (pneumatic)

NEEDLE TYPE
135 x 17

POWER SOURCE
240 v- 1 phase 50-60 Hz
direct drive AC servo motor

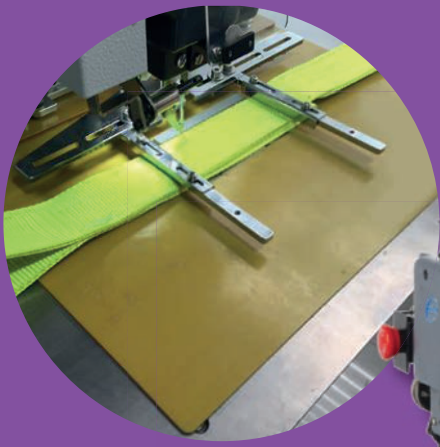

Global BT 250 x 160 LH ELECTRONIC PATTERN SEWING MACHINE

This programmable pattern sewing machine, with extra large hook, is suitable to sew medium / heavy materials with a sewing area of 250 x 160 mm. The height of the presser foot can be adjusted by a stepping motor. Standard equipped with thread breaking sensor and needle cooling. A special clampset for safety belts (max. 4 layers) can be delivered with this machine (optional). The machine is delivered complete with table top, stand and a direct drive mini servo motor. Maximum machine speed 2400 spm. Optional available: quick release clamp.

Máquina de coser programable, con gancho extra grande y corta-hilos, adecuada para coser materiales medianos y pesados con un campo de coser de 250 x 160 mm. La altura de la prensatelas ajustable a través del motor paso a paso. Los dibujos se programa a través del panel de uso fácil. La máquina es apropiada para calzado, bolsas de cuero, etc. Viene equipada con sensor de quebra-hilos y enfriamiento de aguja. Puede suministrar con la máquina un bastidor especial para cinturones de seguridad (de max. 4 capas)- opcional. La máquina será entregada completa con tablón, estante y mini motor servo de tracción directa. Velocidad máxima 2.400 p.p.m. Opcional: anclaje rápido bastidor.

Dieser Nähautomat mit übergroßem Greifer und einem Nähfeld von 250 x 160 mm ist für mittlere bis schwere Materialien geeignet. Der Fusshub ist über einen Schrittmotor programmierbar. Die Muster sind direkt auf dem benutzerfreundlichen Bedienelement programmierbar. Die Maschine wird für Schuhe Ledertaschen ect eingesetzt. Standardmässig mit Fadenwächter und Nadelkühlung ausgestattet. Eine spezielle Klammer für Sicherheitsgurte (maximal 4 Lagen) kann optional mitgeliefert werden. Die Maschine wird komplett mit Tischplatte Gestell und Direct Drive Servomotor geliefert. Maximale Nähgeschwindigkeit: 2400spm. Optional erhältlich: Schnellwechelklammer.

Cet automate de couture, avec crochet très grande capacité et coupe fil, convient pour coudre des matériaux moyens / lourds avec un champ de couture de 250 x 160 mm. La hauteur de relevage du pied presseur peut être ajustée par un moteur pas à pas. Les modèles sont programmables sur le panneau tactile convivial. Cette machine est adaptée pour les chaussures, les sacs en cuir, etc. Equipé en standard d'un lecteur de détecteur de casse de fil et refroidisseur d'aiguille. Un ensemble de pince spécial pour les ceintures de sécurité (max.4 couches) peut être livré avec cette machine (option). La machine est livrée avec table, bati et mini servo moteur direct drive. Vitesse maximale de la machine 2400 ppm. Optionnel: dégagement rapide des pinces.

TECHNICAL SPECIFICATIONS

MACHINE SPEED

Max 2400 spm

FEEDING SYSTEM

By pulse motor (X- Y)

HOOK TYPE

Extra large rotating hook

STITCH LENGTH

max 12,5 mm

PRESSER FOOT LIFT

max 16 mm

CLAMP LIFT

Up to 20 mm (pneumatic)

NEEDLE TYPE

135 x 17

THICKNESS OF SEWING THREAD

max size 15

POWER SOURCE

220-240 volts, single phase,
50-60 Hz direct drive
AC servo motor

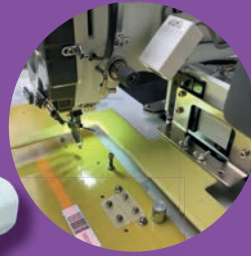
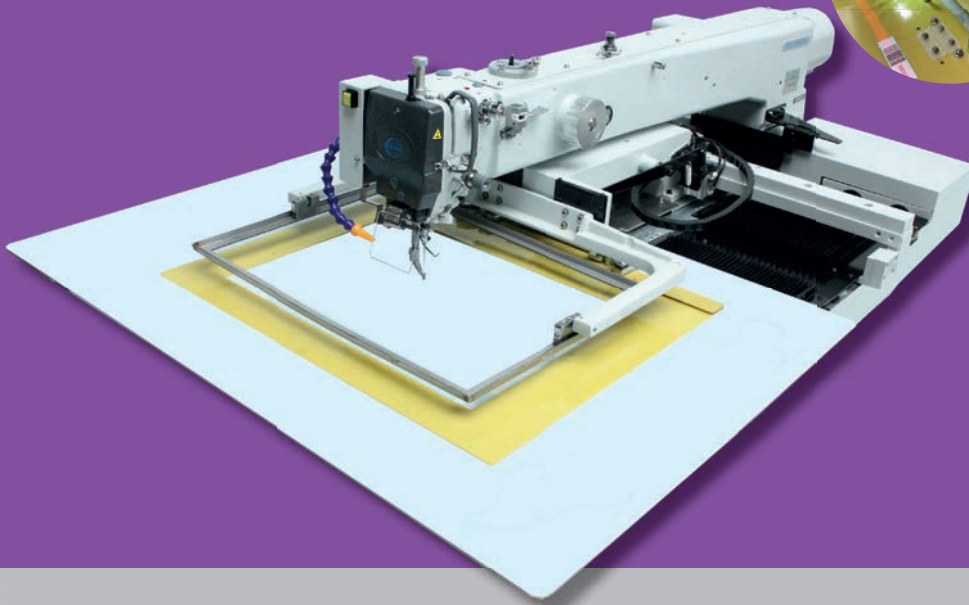

Global BT 300 X 200 / 400 x 300-N ELECTRONIC PATTERN SEWING MACHINE

GLOBAL BT 300 X 200

This programmable pattern sewing machine is suitable to sew medium / heavy materials with a sewing area of 300 x 200 mm. The height of presser foot lifter can be adjusted by a stepping motor. Patterns are programmable on the userfriendly touch panel. The left and right clamp can be programmed to move down independently. The machine is delivered complete with table top, stand and a direct drive mini servo motor. Optional available: bar code reader, quick release clamp, thread breaking sensors, needle cooling, second tension device (not assembled).

Máquina de coser programable adecuada para coser materiales media-pesadas y pesadas con un área de 300 x 200 mm. La altura de la prensatelas programable con el motor paso a paso. Los dibujos son programable a través del panel táctil de uso fácil. La mordaza izquierda y derecha se puede bajar independientes. La máquina viene completa con tablero, estante y mini motor servo de acción directa. Opcional el lector de código de barras, anclaje rápido bastidor, sensor de quebra-hilos, enfriamiento de aguja y segunda dispositivo de tensión de hilo (viene suelto).

Nähautomat für mittlere bis schwere Stoffe mit einem Nähfeld von 300 x 200mm. Der Fusshub ist schrittmotorgesteuert. Nähprogramme werden einfach auf dem Bedienerfreundlichen Touch Panel programmiert. Die und rechte und linke Klammer können jeweils separat programmiert werden. Die Maschine wird komplett geliefert mit Tischplatte, Gestell und Direct Drive Mini- Servomotor. Optional erhältlich: Bar Code Reader, Schnellwechelklammer, Fadenwächter, Nadelkühlung und zweite Fadenspannung (nicht vormontiert).

Automate de couture pour article moyen/lourd avec une surface de travail de 300 x 200 mm. La hauteur du pied presseur est réglable par moteur pas à pas. Les dessins sont programmables à l'aide de la tablette tactile conviviale. Demi pince gauche et droite pouvant être programmés pour descendre indépendamment. Machine livrée complète avec table, bâti et mini servo moteur. Optionnel: d'un lecteur de code barre, dégagement rapide des pinces, détecteur de casse de fil, refroidisseur d'aiguille et deuxième dispositif de tension (non monté).

GLOBAL BT 400 X 300-N

Same as BT 300 X 200, but with a sewing area of 400 x 300 mm. Standard equipped with bar code reader, quick release clamp, thread breaking sensors and needle cooling. Optional available: second tension device (not assembled)

Las mismas características que la BT 300 X 200, pero equipada para área de 400 x 300 mm. Viene equipada con el lector de código de barras, anclaje rápido bastidor, sensor de quebra-hilos y enfriamiento de aguja. Opcional, segunda dispositivo de tensión de hilo (viene suelto).

Baugleich mit BT 300 X 200, jedoch mit einem Nähfeld von 400 x 300mm. Standardmässig mit Bar Code Reader, Schnellwechelklammer, Fadenwächter und Nadelkühlung ausgestattet. Optional erhältlich: zweite Fadenspannung (nicht vormontiert)

Identique au modèle BT 300 X 200, avec une surface de travail de 400 x 300 mm. Equipé en standard d'un lecteur de code barre, dégagement rapide des pinces, détecteur de casse de fil et refroidisseur d'aiguille. Optionnel: deuxième dispositif de tension (non monté).

TECHNICAL SPECIFICATIONS

MACHINE SPEED

BT 300x200 = 2200 spm
BT 400x300-N = 2000 spm

FEEDING SYSTEM

By pulse motor (X- Y)

HOOK TYPE

large rotary hook

STITCH LENGTH

max 10 mm

PRESSER FOOT LIFT

max 16 mm

CLAMP LIFT

Up to 20 mm (pneumatic)

NEEDLE TYPE

135 x 17

SEWING RANGE

BT 300x200 = 300x200 mm
BT 400x300-N = 400x300 mm

POWER SOURCE

240 v- 1 phase 50-60 Hz
direct drive AC servo motor

OPTION:

Pattern design software for PC



CF 988

Global CF 988 THERMO EDGE FOLDING MACHINE

This machine is a good choice for production of shoes and other leather products. This machine is used to fold and at the same time cement the edge of leather goods, and other material of similar nature. The operator guides the piece against the guide and under the creaser foot. This foot holds the material and spreads the cement. Three speed rates are possible: for straight edges, internal and external curves.

Esta máquina es una buena elección para la producción de zapato y otros artículos de cuero. La máquina se aplica para doblar y al mismo tiempo pegar el borde en todo tipo de artículos de cuero y otros materiales de naturaleza similar. El operador conduce el material contra la guía y abajo el pie. El pie mantiene el material y difunde el pegamento. Con posibilidad de tres grados de velocidad: para doblar en recto, doblar con curvas internas y externas.

Esta máquina é uma boa opção para produção de sapatos e outros artigos em pele e sintético. Esta máquina é usada para orlar materiais de pele e sintéticos. O operador encosta o material ao guia debaixo do calcador e este por sua vez vai segurar o material e este vai deitar a cola no material. É possível regular independentemente as velocidades em reta, curva interior e curva exterior.

TECHNICAL SPECIFICATIONS

FOLDING WIDTH
2,5-6 mm

INDUSTRIAL SEWING MACHINES



SK 107



SK 109

Global SK Series SHOE PRODUCTION MACHINES

SK-107 - Seam Opening And Tape Attaching Machine

Seam opening and tape attaching machine equipped with upper and lower presser rollers. This machine gives a perfect finishing to the heel vamp and reinforcing good appearance by pressing the glued heel vamp.

Máquina abriendo costura y pegando cinta equipada con rodillos de presión superior e inferior. Esta máquina da un perfecto acabado talón, refuerza de buena apariencia al presionar el talón pegado.

Ausreibmaschine für Bestechnähte mit Bandaufkleber. Mit oberer und unterer Druckrolle ausgestattet um ein perfektes Resultat zu garantieren.

Machine pour ouverture de couture et fixation de bandes, équipée de rouleaux presseurs supérieurs et inférieurs. Cette machine donne une finition parfaite au talon de l'empeigne et un renforcement de bel aspect en appuyant sur le talon encollé.

SK-109 - Edge Trimming Machine

This machine is designed for edge trimming of various injection moulded vamp, sole- and shoe lining. Suitable for trimming the front part and lining the shoes. Trimming of the rough edge of shoe sole, such as the rubber, plastic, PU shoe sole. It is widely used for riding boots and sandals.

La máquina esta diseñada para recortar los cantos de varias cajas de inyección, suela y foros de zapato. Apropia para recortar la parte delantera y foros de zapato. Recortar el borde áspero de la suela, como caucho, plástico y suela PU. Se utiliza ampliamente para botas para montar caballo y sandalias.

Diese Maschine wurde entwickelt für das Beschneiden von verschiedenen Spritzformsohlen, Schuhsohlen, Schuhfutter und Schuhoberleder. Es lassen sich harte Kanten von Schuhsohlen, wie Gummi, Plastic, PU-Sohlen versäubern. Sie wird außerdem für Reitstiefel und Sandalen verwendet.

Cette machine est utilisée pour rafraichir le bord de chaussures injecté, semelle et doublures de chaussures. Utilisable pour rafraichir la partie avant et la doublure des chaussures. Finition du bord de la semelle des chaussures, en caoutchouc, plastique, semelle de chaussure en PU. Ce matériel est largement utilisé pour les bottes et sandales.

TECHNICAL SPECIFICATIONS SK-107

MOTOR
Low speed

HEIGHT OF POST
300 mm

WEIGHT
22 Kg

TECHNICAL SPECIFICATIONS SK-109

MACHINE SPEED
max 1600 rpm

MOTOR
Low speed

WEIGHT
34 Kg



SK 112-AUT

SK 111

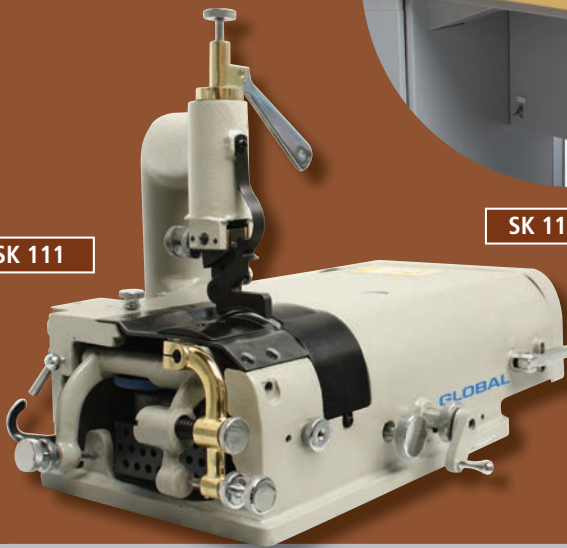

SK 112



Global SK Series SPECIAL LEATHER SKIVING MACHINES

SK 111

- This machine is suitable to skive all kinds of leather products for shoes, bags and belts. Max. skiving width 50 mm.
- Esta máquina de rebajar está preparada para rebajar en cualquier tipo de cuero para productos como el calzado, bolsos y cinturones. Ancho de rebajar máximo 50 mm.
- Diese Schärmaschine ist geeignet für alle Lederprodukten wie Schuhe, Taschen und Gürtel. Maximale Schärfbreite 50 mm.
- Cette machine permet le parage de tous les cuirs utilisés en chaussures, maroquinerie et ceintures. Parage de largeur maximum 50 mm.

SK 112

- High quality skiving machine, speed controlled by foot pedal. This professional machine has easy and precise setting of the height, width and skiving angle. The knife adjustment and pressure control are also easy to adjust. Standard supplied with silicon feed roller. Max. skiving width 50 mm. Max machine speed 1100 RPM.
- Máquina de rebajar de un solo paso de alta calidad, velocidad controlada por pedal. Esta máquina profesional tiene un ajuste fácil y preciso de la altura, el ancho y el ángulo de rebajar el cuero. El ajuste de la cuchilla y el control de presión también son fáciles de ajustar. Estándar suministrado con rodillo de alimentación de silicona. Máximo ancho de rebajar 50 mm. Velocidad máxima de la máquina 1100 SPM.
- Hochwertige Einschnittschärfmaschine mit Geschwindigkeit durch Fußpedal gesteuert. Diese Präzisionsmaschine macht es dem Benutzer sehr einfach sowohl Höhe als auch Breite und Schärfwinkel einzustellen. Messer und Druckkontrolle sind ebenfalls sehr schnell und einfach einzustellen. Standardmäßig mit Vorschubwalze aus Silikon geliefert. Maximale Schärfbreite: 50mm. Maximale Geschwindigkeit: 1100 spm.
- Machine à parer simple pied de haute qualité, avec vitesse contrôlée par la pédale. Cette machine professionnelle possède des réglages simple et précis de la hauteur, la largeur et l'angle de parage. Le réglage du couteau et le contrôle de la pression sont également simples à réaliser. Fournie d'origine avec rouleau d'entraînement en silicone. Largeur max. de parage de 50 mm.

SK 112-AUT

- Same as above, but with stepless electronic drive of feed roll. The electronic feed guarantees a more continuous working process compared to the normal clutch, reduced rejects and guarantees perfect quality. The speed of the feed roll can be adjusted by speed controller (fixed speed) or foot pedal. The skiving machine is delivered complete with table top, stand, motor and waste material suction device.
- Las mismas características que la anterior, pero con un rol de avance electrónico. El avance electrónico garantiza un proceso de trabajo más continuado en comparación con el clutch normal, reduce desperdicios y garantiza una calidad perfecta. La velocidad del rol de avance puede ser ajustado por el controlador de velocidad (velocidad fija) ó el pedal. La máquina de rebajar se suministra completa con tablón, estante, motor y el dispositivo de succión.
- Gleich wie die SK 112 aber mit stufenlosem elektronischem Transportwalzenantrieb. Der elektronische Antrieb garantiert, verglichen mit dem Kupplungsantrieb, einen gleichmäßigeren Arbeitsprozess, weniger Abfall und höchste Qualität. Die Transportgeschwindigkeit kann entweder über einen Geschwindigkeitsregler (fixe Geschwindigkeit) oder das Pedal gesteuert werden. Die Maschine wird komplett mit Tischplatte, Gestell, Motor und Absauganlage geliefert.
- Modèle identique à la version qui précède, mais avec un entraînement continu électronique du galet. L'entraînement électronique garantit un processus de travail plus continu par rapport à celui à embrayage classique, réduit les déchets et garantit une qualité parfaite. La vitesse du galet d'entraînement peut être réglée par le contrôleur de vitesse (vitesse fixe) ou la pédale. La machine est livrée avec table, bâti, moteur et aspiration de déchets.

TECHNICAL SPECIFICATIONS SK-111

MACHINE SPEED
max 1100 rpm

MOTOR
Low speed

SKIVING WIDTH
15 - 50 mm

TECHNICAL SPECIFICATIONS SK-112

MACHINE SPEED*
up to 1100 RPM

MOTOR
Low speed

SKIVING WIDTH
15 - 50 mm

TECHNICAL SPECIFICATIONS SK-112 AUT

MACHINE SPEED*
Stepless adjustable

SKIVING WIDTH
15 - 50 mm

* complete set with suction device



Global SR 9929 SHOE REPAIR MACHINE

Shoe repair machine with universal feed in 360° sewing directions. The machine is equipped with a cylinder arm.

Máquina de reparación de calzado, con prensatelos universal giratorio 360° cosiendo en todas direcciones. La máquina esta equipada con brazo cilíndrico.

Schuhreparaturmaschine mit 360° grad drehbarem Universalfuss. Standardausführung ist diese Maschine mit einem Zylinderarm.

Machine destinée à la réparation des chaussures, munie d'une alimentation sur 360°. Le modèle standard est équipé avec un bras cylindrique.

TECHNICAL SPECIFICATIONS

MACHINE SPEED
max 500 spm

OILING SYSTEM
manual

HOOK TYPE
Small hook

STITCH LENGTH
max 7 mm

PRESSER FOOT LIFT
Max 9 mm

NEEDLE TYPE
135 x 17

SPACE TO RIGHT OF NEEDLE
440 mm



Global SK 118 LEATHER STRAP CUTTING MACHINE

This leather strap cutting machine is designed for precision cutting of leather, artificial leather, vinyl, rubber, etc. It makes even strips, and can cut several strips at a time, which can be used for the production of belts, horse tack, footwear, bags, etc. Machine supplied with switch for reverse rotation, foot pedal for regulating the speed. The machine comes with 8 round blades, 9 spacers of 10 mm and 10 spacers of 1 mm. Extra in the accessory kit 5 spacers 1 mm and 2 spacers 5 mm.

La máquina de cortar tiras de cuero es diseñado para cortar con precisión, cuero, cuero artificial, vinilo, caucho, etc. La máquina genera tiras uniformes y varias tiras a la vez, que pueden ser usadas para la producción de cinturones, tachuelas de caballo, calzado, bolsos, etc. La máquina se suministra con un interruptor para rotar de reversa y pedal para la regulación de velocidad. La máquina está equipada con 8 cuchillas circulares y diferentes medidas de espaciadores.

Diese Lederstreifen Schneidmaschine wurde entwickelt um Leder, Kunstleder, Vinyl, Gummi usw. präzise zu schneiden. Sie schneidet mehrere exakt gerade Streifen gleichzeitig und wird in der Produktion von Gürteln, Pferdegeschirr, Schuhwerk, Taschen usw. eingesetzt. Die Maschine hat einen Schalter für Rückwärtslauf und ein Pedal für die Geschwindigkeitsregulierung. Sie wird mit 8 Rundmessern, 9 Abstandhaltern von 10 mm und 10 Abstandhaltern von 1 mm. Extra: 5 Abstandhaltern von 1 mm und 2 Abstandhaltern von 5 mm.

Cette machine à couper en bande pour cuir est conçue pour la découpe de précision du cuir, du simili cuir, du vinyle, du caoutchouc, etc. Elle produit des bandes régulières et peut couper plusieurs bandes à la fois, qui peuvent être utilisées pour la production de ceintures, des accessoires d'équitation, de chaussures, etc. La machine est fournie avec un interrupteur pour rotation inverse, une pédale pour régler la vitesse. La machine est livrée avec 8 lames rondes, 9 entretoises de 10 mm et 10 entretoises de 1 mm. En supplément dans le kit d'accessoires 5 entretoises 1 mm et 2 entretoises 5 mm.

TECHNICAL SPECIFICATIONS

MACHINE SPEED
Stepless adjustable

MOTOR
Low speed

MAXIMUM CUTTING THICKNESS
6 mm

AVAILABLE SPACERS
1 mm, 5 mm and 10 mm

STRAP WIDTH
Max. 10 cm



RP ATTACHMENT



Global CB 300 AUTOMATIC TAPE DISPENSER

Automatic tape dispenser for non- and self-adhesive tapes and tapes with additional glue and protection foil. CB 300 is a fully programmable tape dispenser equipped with a precise photoelectric cut-off blade controlled by two individual photocells and with the ability to store up to 6 different lengths in the memory.

This tape dispenser does not require any tapes core support or shaft, and enables to easily process two tapes simultaneously. **Optional available:** RP attachment - The function of this attachment is to peel off the backing material of the tape with additional foil protection and wind the backing material. The maximum outside diameter of roll is 150mm.

Cortador de cinta no adhesiva, adhesiva y adhesiva de doble cara. Global CB 300 es un cortador de cinta totalmente programable, con un cuchillo de control foto-electrico preciso de dos fotocélulas individuales y capacidad de memorizar 6 diferentes tamaños. El Cortador de cinta no necesita soportes ó ejes especiales para las cintas y puede procesar fácil con dos cintas simultaneamente. **Disponible opcional** el dispositivo RP - Dispositivo para pelar la hojuela de protección de la cinta adhesiva normal ó de doble cara. La máxima diametro de los extremos exteriores del rollo es de 150 mm.

Automatischer Bandsepender für selbstklebende und nicht klebende Bänder sowie für doppelseitig klebende Bänder mit Schutzfolie. Der CB 300 ist ist voll programmierbar mit einem präzisen Abschneidemesser das über 2 Fotozellen kontrolliert wird und bis zu 6 verschiedene Längen speichern kann. Die Maschine benötigt keine zusätzliche Bandhalter, und erlaubt es 2 Bänder simultan zu bearbeiten. **Optional erhältlich:** Abzieh - und Aufrollvorrichtung für Schutzfolie bei doppelseitigem Klebeband. Maximaler Aussendurchmesser der Rolle: 150mm.

Distributeur de bande automatique pour ruban non adhésifs et auto-adhésifs, pour ruban avec colle supplémentaire et feuille de protection. Le CB 300 est un distributeur de bandes entièrement programmables doté d'une lame de coupe photoélectrique précise contrôlée par deux photocellules individuelles et capable de stocker jusqu'à 6 longueurs différentes en mémoire. Ce distributeur de bande ne requiert aucun support ou axe de bande, et permet de traiter facilement deux bandes simultanément. **Option disponible:** Fixation RP - La fonction de cet accessoire est de retirer le matériau de support du ruban avec une protection additionnelle et d'enrouler le matériau de support. Le diamètre extérieur maximal du rouleau est de 150 mm.

TECHNICAL SPECIFICATIONS

CUT LENGTH
5 - 999 mm

TAPE WIDTH
6 - 60 mm

USEABLE TAPE
Backing Papered, Double-Sided, Copper Foil

USEABLE NON ADHESIVE MATERIAL
Protection Film, Paper Tape, Copper Foil etc.

FEEDING SPEED
Max. 200 mm/sec (depends on tape material)

POWER SUPPLY
AC 240V - 50/60Hz - 25W

*Some of usable tapes may not cut, depends on material/tape manufacturer.



HP 600 S



HP 9450

HP 9450

Global HP SERIES RUNNING SEAL PRESS

The special pressure mechanism is made for pressing all kinds of materials. The electronic thermostat and the special heater minimize temperature-variation. The HP press uses an excellent heat-proof teflon belt.

El mecanismo especial esta adaptado para presionar todo tipo de materiales. El termostato electronico y la calefacción especial minimizan la variación de temperatura. HP termofijadora continua tiene una banda de transporte de teflon perfectamente resistente al calor.

Durchlauf-Fixier-presse. Der spezielle Druckmechanismus ist zum Pressen aller Arten von Materialien geeignet.

Le mécanisme spécial de pression permet le thermocollage de tous tissus. Le thermostat électronique et la résistance spéciale réduisent les variations de température. Le presse HP utilisent une bande teflon d'une excellente résistance à la chaleur.

Model	voltage	Power (watt)	Fusing width	Belt speed (max)	Pressure (max) kgf/cm	Temp. (max)	Heating time
HP 9450	220 V- 1 ph	4,5 kW	450 mm	8,7 m/min	1,50	195°	5-20 sec
HP 600 S	220/380 V - 3 ph	8,7 kw	600 mm	10,2 m/min	6,04	195°	6-28 sec
HP 900 S *	220/380 V - 3 ph	12,3 kw	900 mm	10,2 m/min	4,02	195°	6-28 sec

*Only on special request. No stock item.

TECHNICAL SPECIFICATIONS

DIMENSIONS (LXWXH)

HP 9450 :1660 x 880 x 490 MM
 HP 600 S: 3100 x 1190 x 1200 MM
 HP 900 S: 3300 x 1490 x 1200 MM

WEIGHT

HP 9450 : 152 Kgs
 HP 600 S : 380 kgs
 HP 900 S : 450 kgs

STANDARD

Strip-Off Device

OPTIONAL

Stand for HP 9450



INDUSTRIAL SEWING MACHINES



HO HSING Servo motors

As the main European distributor of Ho Hsing motors, Global supplies customers not only with a state of the art motor for every brand of sewing machine, but also with the service customers need to have maximum performance from their sewing machines. With our own Ho Hsing service department, Global can guarantee full after sales support, repair and provide you with all the information you need about the latest Ho Hsing technologies and updates.

G series:

To meet the demand for a cheaper, high quality energy saving motor with needle positioning, Ho Hsing introduced the G series that is sold all over the world for many years now. With a wide range of parameters the G series can be set to drive your machine perfectly.



Available G series models:

G40-1: 400 Watt motor body for high speed lockstitch, overlock, blind stitch and normal interlock.

G60-1: 600 Watt motor body, because of the relative high torque the G-60 can be used on some heavier machines like light to medium weight walking foot machines.

G60-2: same as G60-1 but with output for PNEUMATIC presser foot lifter and needle cooling (motor run signal).

G60-1-NP: same as G60-1 only with speed potentiometer to limit the max. speed easily.

G75-2: same as G60-2 but with 750 Watt power (output for PNEUMATIC presser foot lifter and needle cooling / motor run signal). Not suitable for machines with a big handwheel like Global WF 9204 / 9205.

External synchro 700-1 comes as an option. G series can work with or without external synchroniser and there is no need to change any settings for this, the control box will automatically detect the external synchro and adjust itself.

Model	Power	Voltage (1 phase)	Standard motor pulley	PFL (air only)	Needle cooling
G40-1-00-220	400 W	220 – 240 V	90 mm.	-	-
G60-1-00-220	600 W	220 – 240 V	65 mm.	-	-
G60-1-NP-220	600 W	220 – 240 V	65 mm.	-	-
G60-2-GL-220	600 W	220 – 240 V	65 mm.	√	√
G75-2-GL-230	750 W	220 – 240 V	65 mm.	√	√



HO Hsing Servo motors

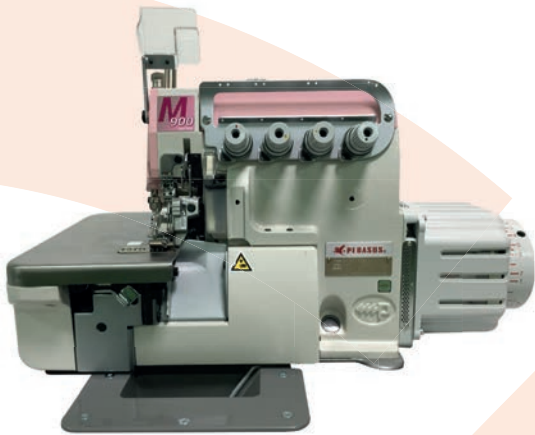

HD40 direct drive set for several models of Juki, Pegasus, Yamato overlock sewing machines:

HD40 Series is the replacement of the GD40 Series. For less vibrations and smoother running of your overlock machine, a direct drive mini motor is mounted directly on the drive shaft of your overlock machine. A separate HD40 control box is mounted under the table. A special bracket that matches your machine model is included in the set.

A presser foot can be lifted pneumatically and in combination with a photocell the HD40 series can control air suction at the beginning and at the end of sewing (air saving) and control a tape cutter.

MH series:

To replace the successful MA series, the powerful 600 Watt MH series ensures high performance on your light or medium weight lockstitch, overlock or interlock applications. Suitable for many automatic machines with reverse, trimming, wiping, tension release and presser foot lift.

Unlike the MA series, on MH series all settings can also be made on the control box, therefore, C200M operating panel is optional.

Available models: Mitsubishi model only



i90 series:

This motor needs no further introduction, with its high torque and solid motor body i90M series supersedes the world wide famous HVP-90 series and is suitable to drive even heavy duty machines like Global WF 9204. With its great variety of functions it can be used on a wide range of special sewing machine applications.

Available models in 550 Watt: Global, Brother, Juki and Mitsubishi.

Available models in 750 Watt: Global, Dürkopp Adler.





HO HSING Servo motors

GM60-5-GL-220

A simple, small and low control box with 600 Watt mini motor and external synchroniser together as a set in one carton box. Available functions: needle positioning, trimming (magnet or pneumatic), tension release (only pneumatic), presser foot lift (only pneumatic) and needle cooling function. Safety switch input available. Can be used on interlock with under bed trimmer and light to medium weight walking foot applications. A separate speed control unit is supplied which is convenient for long arm machines.

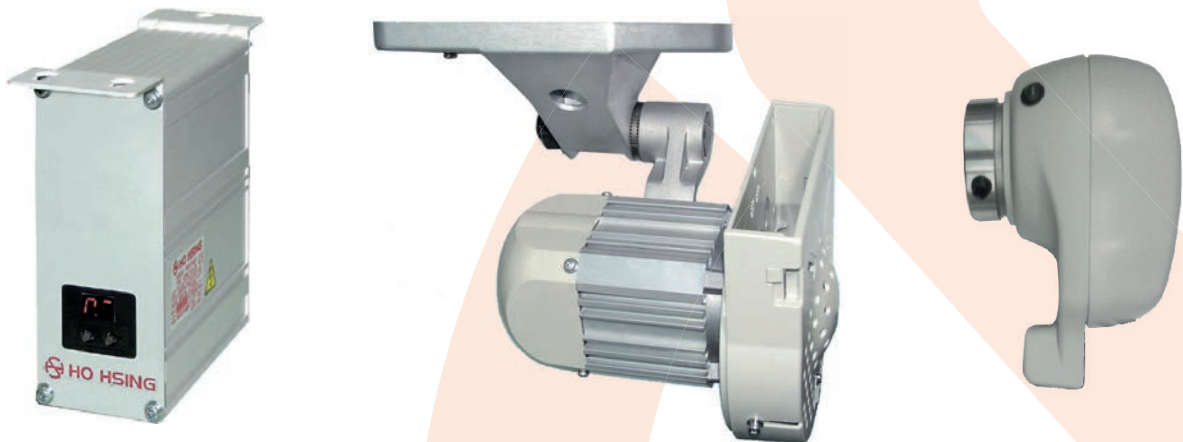

i50 series:

Low cost set of separate control box and 400 Watt motor body for simple automatic high speed lockstitch and chainstitch machines. A 600 Watt model is also available for light to medium weight walking foot machines and with functions like trimming, back tack and presser foot lifter the i50 series is suitable to be used on a variety of machine brands and models.

Operating panel is only necessary for programming parameters and changing of settings like back tack stitch setting and trimming. After installation the operating panel can be disconnected.

External synchronizer is optional, i50 series can work with the built in Juki or Brother synchronizer or an external synchronizer.

With standard settings for Juki and Brother high speed lockstitch these models are ready to run after installation. Connectors are original Juki and Brother type.

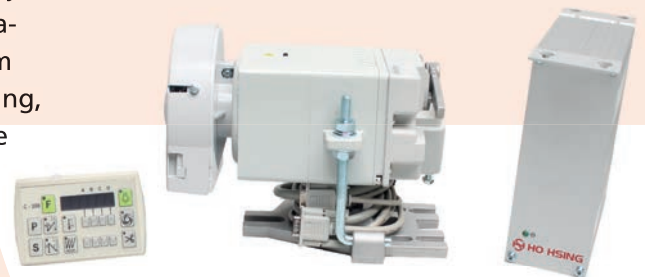

Global code	Model	Power	Voltage (1-phase)	Standard for
i5017W	i50-4-7W-220	400 Watt	220 – 240 V	Juki high speed lockstitch
i501BR	i50-4-BR-220	400 Watt	220 – 240 V	Brother high speed lockstitch
i502BR	i50-4-BR-220	600 Watt	220 – 240 V	Various models



HO HSING Servo motors

i60 and i70 series:

Separate control box that can be used in combination with a 500, 600 or 750 Watt mini motor. By choosing the correct mini motor for your sewing machine application a wide variety of sewing machine models can be equipped with this control unit (including direct drive). Operating panel C-200 (i60) or C300 (i70) is optional.

Available functions (depending on the control box model):

trimmer, wiper, tension release, presser foot lift, reverse, HP function, second stitch length, puller, material guide, photocell input and flip flop function.

i60 and i70 models use a separate speed control unit that can be installed in a random position under the table, therefore very convenient for long arm machines.

Available i60 models: Global, Dürkopp Adler, Brother, Juki, Mitsubishi and Pegasus.

Available i70 models: Dürkopp Adler (i70L) , Global, Brother, Mitsubishi, Pegasus (i70M), Juki.



Mini motors for i60, i70 series:

i60 and i70 series work in combination with a separate mini motor. With the 500, 600 and 750 Watt models a wide range of sewing applications is covered. The mini motors for under the table are supplied including mounting bracket, V-belt cover and motor pulley.

Also a variety of direct drive models are available.

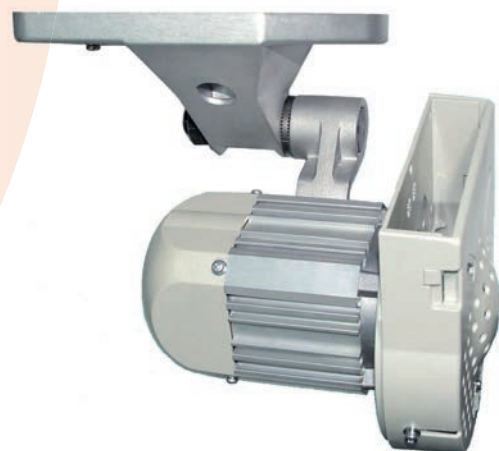

Accessories:

AC0001 - photocell NPN – adjustable sensitivity

AC0002 - standing operation pedal SOP-6H3 for Ho Hsing motor (6-pin plug incl. adapter cable for i70 series)

AC0003 - standing operation pedal SOP-8G for G series (4-pin plug)

AC0004 - synchronizer adapter set 1180-2



HO HSING Servo motors

Global code	Ho Hsing code	Description	Optional Synchro	Operating panel	Connector
G40100	G40-1-00-220	400 Watt G series motor without synchro	SY01GG	-	-
G60100	G60-1-00-220	600 Watt G series motor without synchro	SY01GG	-	-
G601NP	G60-1-NP-220	Like G60100 but with max. speed potentiometer	SY01GG	-	-
G60200	G60-2-GL-220	Like G60100 with output for PNEUMATIC PFL and needle cooling	SY01GG	-	Included
G70200	G75-2-GL-230	Like G60200 but with 750 Watt motor body	SY01GG	-	Included
GM60GL	GM60-5-GL-220	Complete set with 600 W. mini motor and synchroniser	Incl.	-	Included
HH0211	MH-4-11-220	600 Watt Mitsubishi style MH motor	SY0128	OP0205	CS7002
i5017W	i50-4-7W-220	400 Watt Juki style i50 motor set	SY0130	OP0205	Included
i501BR	i50-4-BR-220	400 Watt Brother style i50 motor set	SY0129	OP0205	Included
i502BR	i50-4-BR-220	600 Watt Brother style i50 motor set	SY0129	OP0205	Included
i601BR	i60-4-BR-220	Brother model control box i60	SY0129	OP0405	CS9003
i60111	i60-4-11-220	Mitsubishi model control box i60	SY0128	OP0405	CS9003
i6017W	i60-4-7W-220	Juki model control box i60	SY0130	OP0405	CS037W
i60166	i60-4-66-220	Pegasus model control box i60	SY0129	OP0205	-
i601GL	i60-4-GL-220	Dürkopp Adler / Global LP 2971 AUT model control box i60	SY0129	OP0305	CS00ED
i70111	i70M-4-11-220	Mitsubishi style control box i70M	SY0128	OP0102	CS9003
i7017W	i70M-4-7W-220	Juki style control box i70M	SY0130	OP0102	CS037W
i701BR	i70M-4-BR-220	Brother style control box i70M	SY0129	OP0102	CS9003
i701ED	i70L-4-ED-220	Dürkopp Adler style control box i70L	SY0129	OP0102	CS00ED
i90211	i90M-4-11-220	Mitsubishi style 550 Watt i90M	SY0128	OP0202	CS9003
i9027W	i90M-4-7W-220	Juki style 550 Watt i90M motor	SY0130	OP0202	CS037W
i902BR	i90M-4-BR-220	Brother style 550 Watt i90M motor	SY0129	OP0202	CS9003
i90411	i90M-4-11-220	Mitsubishi style 750 Watt i90M motor	SY0128	OP0202	CS9003
i904LU	i90M-4-LU-220	i90M motor 750 Watt for Global WF 1500 series	SY0130	OP0202	-
i904HY	i90M-4-HY-220	i90M motor 750 Watt for Global WF 1520 series	SY0130	OP0202	-
i904ED	i90M-4-ED-220	Dürkopp Adler style 750 Watt i90M motor including synchro	Incl.	OP0202	CS00ED
Global code	Ho Hsing code	Description	Rated speed	Motor pulley	
MT0150	M1-50AB-007	Mini motor 500 W with mounting bracket and V-belt cover	5000	75	
MT0250	M1-50AB-104	Mini motor 500 W direct drive one index signal	5000	-	
MT0350	M1-50AB-007	For chainstitch. MT0150 but with pulley 85 instead of 75 mm.	5000	85	
MT0160	M1-60FE-020	Mini motor 600 W with mounting bracket and V-belt cover	3500	75	
MT0260	M1-60FE-118	Mini motor 600 W direct drive one index signal	3500	-	
MT0175	M1-75CC-012	Mini motor 750 W with mounting bracket and V-belt cover	2500	75	
MT0275	M1-75CC-108	Mini motor 750 W direct drive one index signal	2500	-	
MT0375	M1-75EC-006	Mini motor 750 W with mounting bracket and V-belt cover	3500	75	
Global code	Ho Hsing code	Description	Global code	Ho Hsing code	Description
SY0128	600-28	External synchro Mitsubishi model for Ho Hsing -11	Rectangular 6 pin		
SY0129	600-29	External synchro Brother , Dürkopp Adler and more –BR and -ED	Round 8 pin		
SY0130	600-30	External synchro Juki model for Ho Hsing -7W and -LU	Round 7 pin		
SY01GG	700-1	External synchro for G series	Rectangular 4 pin		
Global code	Ho Hsing code	Description	Global code	Ho Hsing code	Description
OP0102	C-300	Operating panel for i70M and i70L series	9 pin D sub		
OP0103	C-60	Operating panel including parameter setting for special models	9 pin D sub		
OP0202	C-300M	Operating panel for i90M series	Mini DIN		
OP0203	C-60M	Operating panel including parameter setting for i90M	Mini DIN		
OP0205	C-200M	Operating panel for MH series and i60-4-66-220	Mini DIN		
OP0305	C-210M	Operating panel for i60-4-GL-220	Mini DIN		
OP0405	C-200	Operating panel for i60 model -BR, -11 and -7W	9 pin D sub		



TD 2970



Global LP 2970 Series (options)

SPECIAL LIGHT AND EDGE GUIDES FOR GLOBAL LP 2970 SERIES AND DÜRKOPP/ADLER 838/888 SERIES

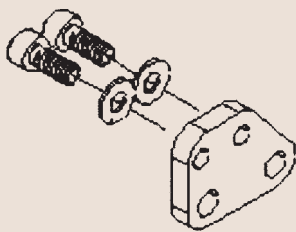

N800 080003-GP
Bracket for edge guide

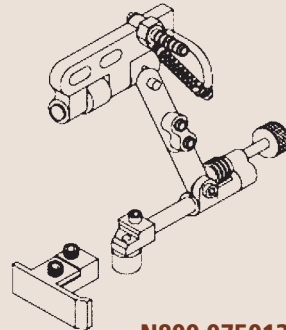

N800 075013-GP
Edge guide

N800 080030



0888 220610



0888 271538



0888 271529

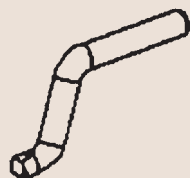

0888 271539

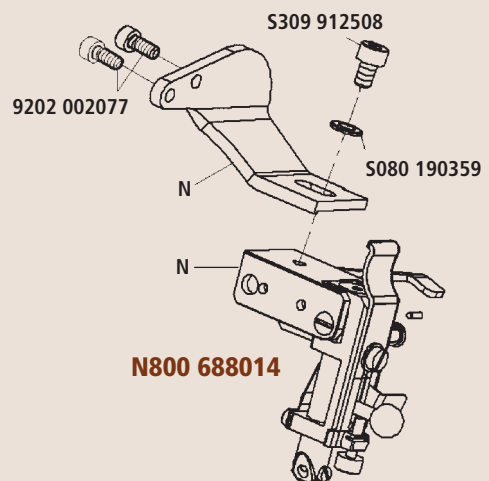

N800 688014

LED TECHNOLOGY

GLOBAL PARTS

SAVE UP TO
90%
ENERGY



TD-10
FS FLEXIBLE
ARM



TD-3
A-B-C

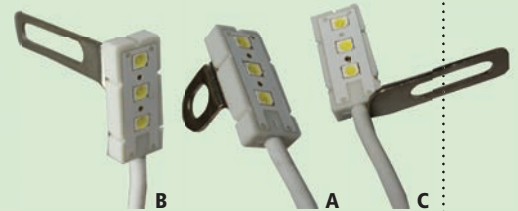

B

A

C



TD-5
SINGLE
HEAD



TD-6
U-SHAPE



TD-28C

TD-28C
XL



TD-6 DH
DOUBLE
HEAD



TD-20
FS FLEXIBLE
ARM

GLOBAL
PARTS

Global Parts by
Hendrik Figeeweg 4b
Ind. Estate Waarderpolder
2031 BJ Haarlem - Holland

PHONE +31 23 542 53 12
FAX +31 23 542 34 22
E-MAIL globalparts@planet.nl
WEB www.globalsew.com

Spare parts for the Global Selection

GLOBAL PARTS

We at Global Parts are specialised in spare parts for the Global line of machines. At our modern operation facility we give our customers the best possible service. We are very proud of our 90% 'off-the-shelf' delivery of Global spare parts, because of our large inventory.

Spare parts
for the
Global Selection



GLOBAL
PARTS

Global Parts bv
Hendrik Figeweg 4b
Ind. Estate Waarderpolder
2031 BJ Haarlem - Holland

PHONE +31 23 542 53 12
FAX +31 23 542 34 22
E-MAIL globalparts@planet.nl
WEB www.globalsew.com

WWW.GLOBALSEW.COM



Global International BV

Hendrik Figeeweg 4
2031 BJ Haarlem
The Netherlands
Phone : (31) 23-5319584
Fax : (31) 23-5311022
E-mail : info@globalsew.com

Global Parts bv

Hendrik Figeeweg 4B
2031 BJ Haarlem
The Netherlands
Phone : (31) 23-5425312
Fax : (31) 23-5423422
E-mail : globalparts@planet.nl

IMCA France

3 Square des Bouleaux
49300 Cholet
France
Phone : (33) 2 4158 8148
Fax : (33) 9 5618 8148
E-mail : imcafrance@gmail.com